



Installation / User Manual

APsystems ECU-C Energy communication unit with advanced functions



Please scan this QR code
to download our APPs

© All Rights Reserved

or click the link below:
<http://q-r.to/1OrC>

Table of Contents





Important Safety Instructions	3
1.Introduction	4
2.Interface Explanation	5
2.1 AC Input Port.....	6
2.2 DC Input Port.....	6
2.3 RJ45 Ethernet Network Port.....	6
2.4 RJ45 Signal (Only for Australia)	6
2.5 AP.....	7
2.6 Power.....	7
2.7 USB Port.....	7
2.8 Reset.....	7
2.9 Antenna.....	7
2.10 LED.....	8
3.Hardware Installation	9
3.1 Preparation.....	9
3.2 Selecting an Installation Location for the ECU-C.....	9
3.3 Cable Connections.....	11
3.4 RJ45 Signal connection.....	11
3.5 Internet Connection.....	11
3.6 Current transformer interface.....	13
3.7 Contactor connection.....	14
4.Basic Operation	15
4.1 Restore the factory set operation.....	15
5. EMA Manager	16
5.1 Connecting to the ECU-C via the Local Wireless.....	16
5.2 Add UID.....	17
5.3 Historical ID.....	17
5.4 Delete UID.....	18
5.5 Grid Profile.....	18
5.6 Time management.....	19
5.7 Meter Settings.....	19
5.8 Modbus Settings.....	22
5.9 ECU Network Settings.....	24
5.10 Checking the commissioning of the ECU-C.....	26
5.11 Module.....	27
5.12 Data.....	28
5.13 Inverter Connection Progress.....	29
5.14 Automatic System Check.....	29
5.15 ECU AP Settings.....	30
5.16 Do-It-Yourself(DIY) Registration.....	31
5.17 Settings.....	32
6.Local Network Interface	33
6.1 Connecting to the ECU-C via the Local Wireless.....	33
6.2 Home Screen.....	33

Table of Contents

6.3 Real-time Data Screen.....	35
6.4 Administration Screen.....	35
6.5 Advanced Screen.....	38
7.Remote ECU-C Management (EMA).....	40
7.1 ECU-C Configuration/ECU-C Status Page.....	41
7.2 Setting the ECU-C Time Zone.....	42
7.3 Managing Inverter IDs and Updating the Inverter ID List.....	42
8.Technical Data.....	44

Important Safety Instructions

Symbols replace words on the equipment, on a display, or in manuals

 APsystems	Trademark.
	Caution, risk of electric shock.
	Equipment protected throughout by double insulation or reinforced insulation
	CE mark is attached to the solar inverter to verify that the unit follows the provisions of the European Low Voltage and EMC Directives.
Qualified personnel	Person adequately advised or supervised by an electrically skilled person to enable him or her to perceive risks and to avoid hazards which electricity can create. For the purpose of the safety information of this manual, a "qualified person" is someone who is familiar with requirements for safety, refrigeration system and EMC and is authorized to energize, ground, and tag equipment, systems, and circuits in accordance with established safety procedures. The inverter and endues system may only be commissioned and operated by qualified personnel.

1.Introduction

The APsystems Energy Communication Unit (ECU-C) is the information gateway for our microinverters. The unit collects module performance data from each individual microinverter and transfers this information to an Internet database in real time. Through the APsystems Energy Monitoring and Analysis software, the ECU-C gives you precise analysis of each microinverter and module in your solar installation from any web-connected device. The ECU-C's integrated http web server offers the simplest and most flexible network integration of any data logger on the market. The user-friendly browser-based interface lets you access your solar array in seconds.

Features

- Collects individual module and microinverter statistics
- Remote communication
- Requires no additional wiring
- Applicable commercial system

The APsystems Microinverter is used in utility-interactive grid-tied applications, and is made up of three key elements:

- APsystems Microinverter
- APsystems Energy Communication Unit (ECU-C)
- APsystems Energy Monitoring and Analysis (EMA) web-based monitoring and analysis system

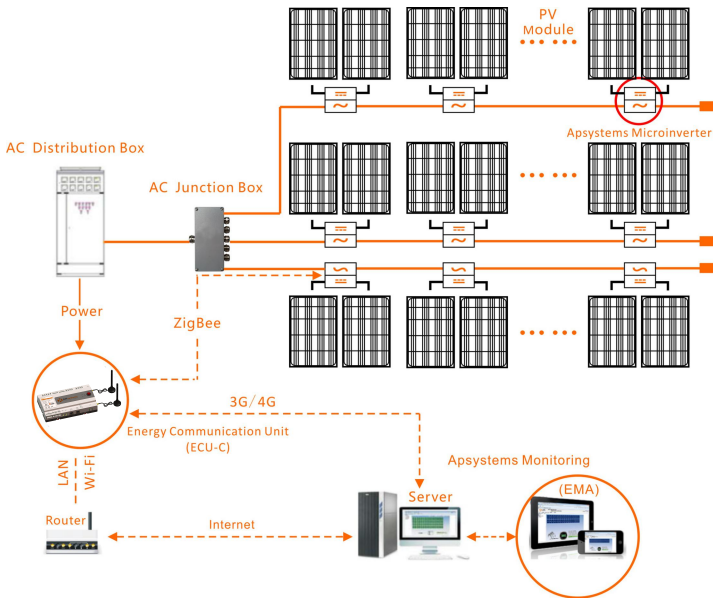

Figure 1

2.Interface Explanation

Interface Layout

The ECU-C interface includes, (figure 2)from left to right, are AC Input、Production CT、Grid CT、Relay Output、Relay Feedback Input、Reset.

(figure 3)from left to right, are Port、DC、RS232、RS485、USB1、USB2、RJ45、Internet、RJ45 Signal、AP.

(figure 4)from left to right, are antenna(Zigbee)、antenna(Wifi).

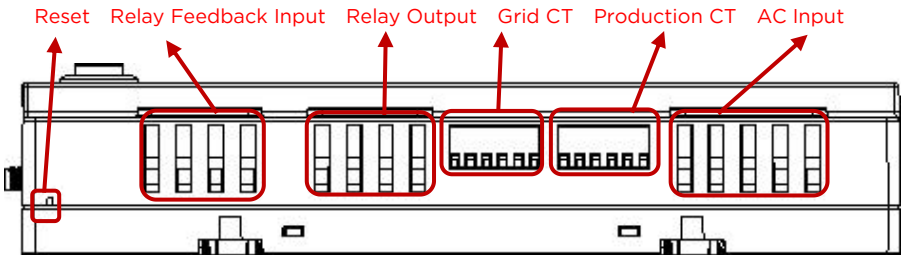

Figure 2

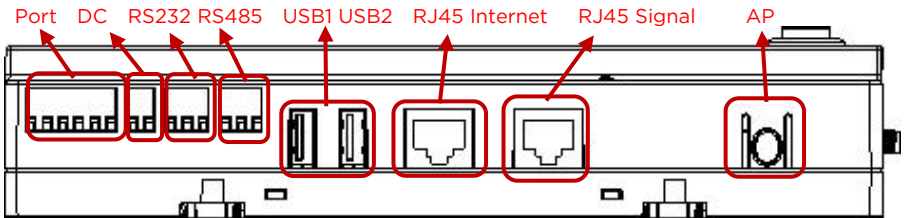

Figure 3

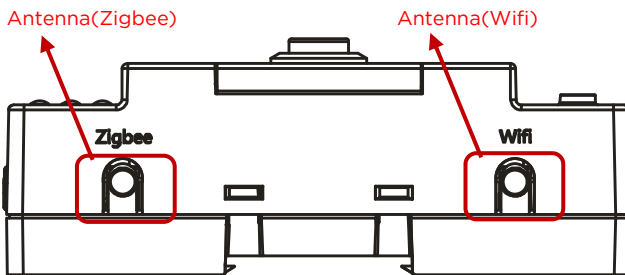

Figure 4

2.Interface Explanation

2.1 AC Input Port

The AC Input port connects power through the power line.If only single-phase power is needed, the L1 must be connected.

	L1	L2	L3	N	PE
Three Phase	√	√	√	√	√
Single Phase	√	x	x	√	√

NOTICE

The AC input power should be assembled with disconnector(e.g. when the current is bigger than 1A, the disconnector should be operated).

2.2 DC Input Port

The DC Input port connects power through the 16V DC power line.

2.3 RJ45 Ethernet Network Port

The ECU-C allows the user to communicate with the EMA, or log in to the ECU-C's local page in the absence of the wired LAN and WLAN, to set up the system and view the system data via Ethernet network port.

NOTICE

Ethernet cable connection is recommended for stable communication.

2.4 RJ45 Signal (Only for Australia)

The RJ45 Signal is designed for DRM0/5/6/7/8, it should be connected by RJ45 connector in the package otherwise the inverters will not work.

NOTICE

Please do not plug out the RJ45.

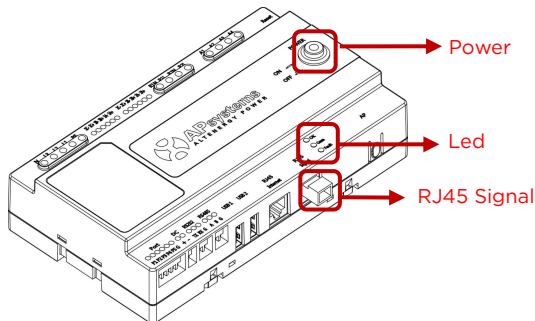

Figure 5

2.Interface Explanation

2.5 AP

The AP button enables to turn on the ECU wifi hotspot. When setting up the ECU, installer needs to first connect to the ECU hotspot via his smart phone or tablet. Press the AP button for a few seconds: the ECU hotspot will be live for one hour. If more time is needed to set-up the ECU, press the AP button to reactivate the hotspot.

2.6 Power

Press the button, ECU will be powered on. Press the button again, the button would bounce back and ECU will be powered off.

2.7 USB Port

North America ONLY: for cellular communication using an external 4G dongle. It is recommended to only use the cellular communication in areas where there is no easy access to Wireless or Ethernet network. Only 4G Dongle supplied by APsystems are compatible with our ECU-C.

2.8 Reset

Press the Reset button for three seconds or longer, and the ECU-C will automatically return to the default settings.



NOTICE

The historical power generation won't be cleared.

2.9 Antenna

The antennas supplied with the ECU-C must be connected to the ECU-C. One antenna is used for the communication between ECU-C and microinverters (Zigbee signal), the other antenna is used for the Wi-Fi connection between ECU-C and router.

2.Interface Explanation

2.10 LED

The OK light will blink when ECU-C starts up, and it will keep on after registering.

The Comm light will be on when the ECU-C connects to EMA.

The Fault light will be on when the ECU-C breaks down.

3. Hardware Installation

3.1 Preparation

Make sure you have the following components ready before beginning to install the ECU-C:

- A broadband Internet connection available for your use.
- A broadband router with either a CAT5 Ethernet, or a wireless router .
- A laptop with a web browser (to view the APsystems EMA online monitoring application).
- A pre-programmed ECU-C.

3.2 Selecting an Installation Location for the ECU-C

- Choose a location that is electrically as close to the array as possible.
- The ECU-C is NOT rated for outdoor use, so if installing outdoors near a junction box or breaker panel, make sure you enclose it in an appropriate weatherproof NEMA electrical box.
- **Avoid to install in the place children can not touch.**

1) Power Distribution Cabinet Installation

If you use the energy communicator in power distribution cabinet:

- Pull the four snap out with a screwdriver.

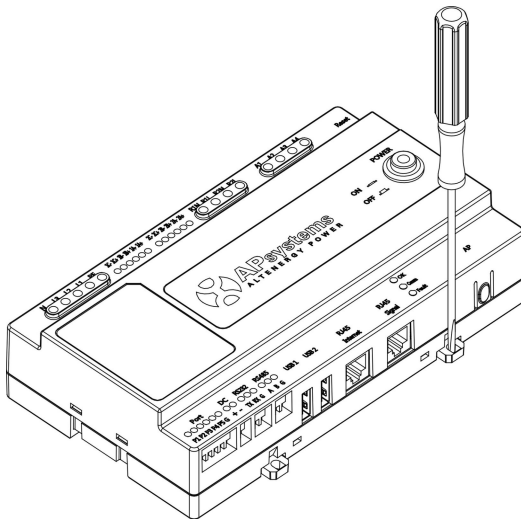

Figure 6

3. Hardware Installation

- Attach two buckles below in the edge of the guide, press two buckles above, then embed to the edge of the guide.

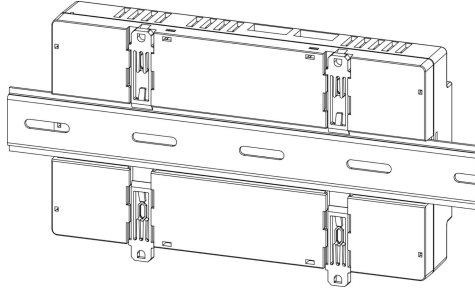

Figure 7



NOTICE

Do not put the antennas inside a metal box, that will block the signal. If the roof is metal, please use this long cable antenna, and place it outside or on roof.

2) Using a Wall Mount

When mounting the ECU-C to a wall, make sure to select a cool, dry indoor location.

- According to the size of an icon, The energy communicator is fixed on the wall with two Wall screws or wall anchors.
- Four M4 screws + spacers are fixed to the wall, and the punch sizes are as follows:

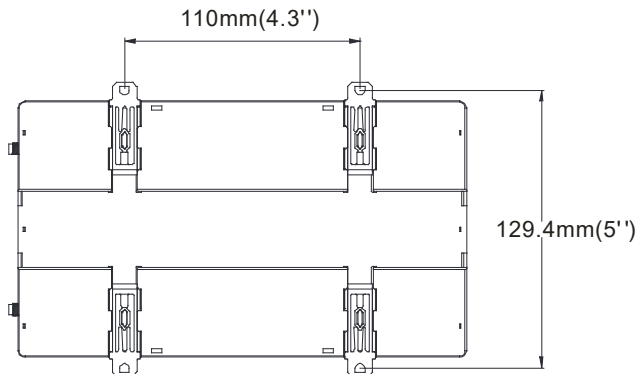

Figure 8

3. Hardware Installation

3.3 Cable Connections

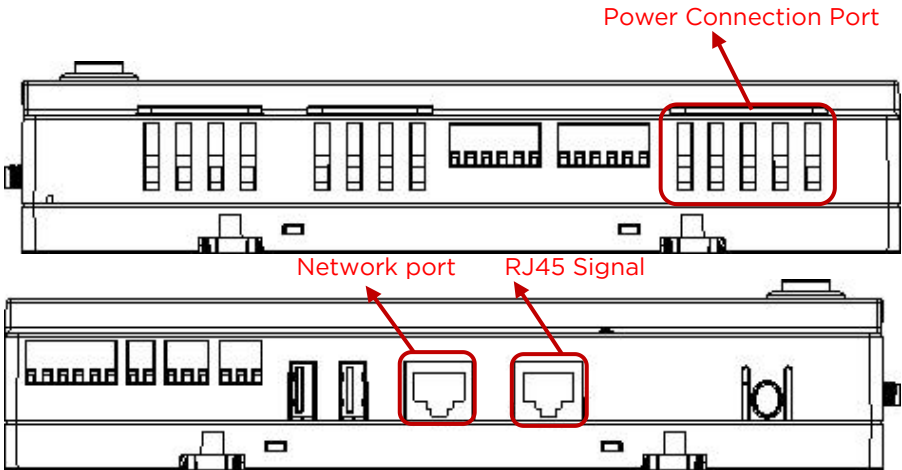

Figure 9

- Connect the power cable to the power connection port on the top of the ECU-C. (Can also be DC power supply).
- Connect the supplied LAN cable to the network port on the bottom of the ECU-C.

3.4 RJ45 Signal connection

Plug the RJ45 connector in the package to RJ45 Signal port.

3.5 Internet Connection

There are three different approaches to connecting the ECU-C to the Internet:

Option 1: Direct LAN cable connection.

- 1) Make sure the LAN cable is connected to the network port on the bottom of the ECU-C.
- 2) Connect the LAN cable to a spare port on the broadband router.

3. Hardware Installation

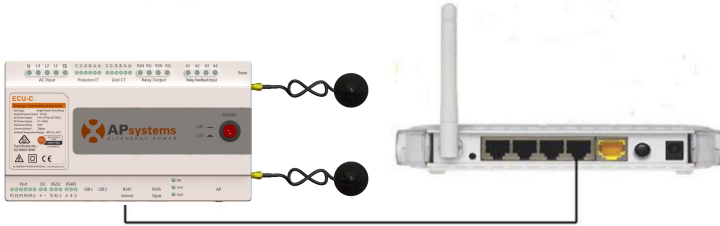

Figure 10

Option 2: Wireless Connection.
Use ECU-C internal WLAN (see Managing the WLAN Connection, pg. 23).

Option 3: Using a PLC bridge:

- 1) Make sure the LAN cable is connected to the network port on the bottom of the ECU-C.
- 2) Connect the LAN cable to the “send” unit of the PLC bridge.
- 3) Connect a LAN cable from the “receive” unit of the PLC bridge to a spare port on the broadband router (refer to the bridge users manual for specific operating instructions).

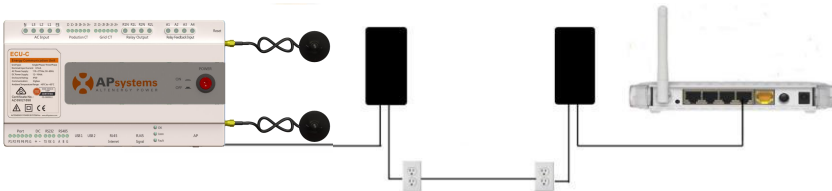

Figure 11

NOTICE

The network cable in the package can be used to connect the ECU-C with PC directly. One side is connected with the ECU-C and the other side is connected with the PC. Then change the IP address and the network mask to 192.168.131.1 and 255.255.255.0, respectively.

NOTICE

1. A PLC bridge uses the power line to communicate and requires both a “send” and “receive” unit.
2. The quality and length of the LAN cable will affect the ECU-C communication quality. You can use a Switch to enhance the communication quality if necessary.

3. Hardware Installation

3.6 Current transformer interface

By installing Current Transformer(CT), the integrated meter in ECU-C can measure the production&consumption power and energy. Please refer to the picture.

It is mandatory to install the current transformer on production and consumption side to get the anti-backflow function.

Anti-backflow function manages inverters one by one: it turns on/off each inverter through zigbee communication, in order to get production inferior or equal to consumption.

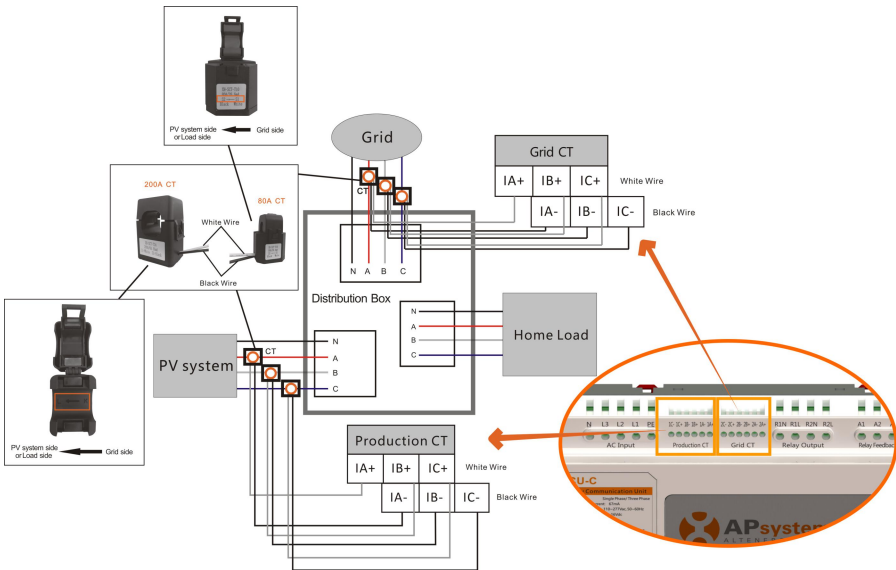

Figure 12

NOTICE

Please ensure that the ECU-C is in a power off state when installing the transformer. APsystems can provide the current transformers, please contact us or our distributors.

3. Hardware Installation

3.7 Contactor connection

ECU-C provides two contact driver signal interface, two-way contact signal interface.

Interface	Interface description
R1L	The first road contactor drives the output L, and is connected with the power supply interface L1.
R1N	The first road contactor drives the output N, and is connected with the power supply interface N.
R2L	Second road contactor driver output L, with the power supply interface L1.
R2N	Second road contactor driver output N, with the power supply interface N.
A1 A2	First contact feedback signal input, non polarity.
A3 A4	Second way contactor feedback signal input, non polarity.

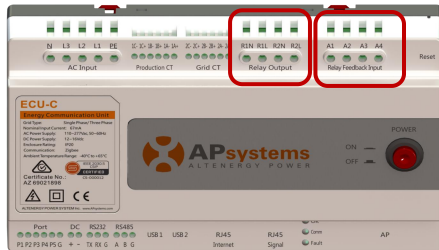

Figure 13

ECU-C automatic detection and judgment of the current power grid environment, through the drive signal interface to control the opening or closing of the contactor. The feedback signal interface and NO of contactor are often connected to inform the ECU that the contactor is effectively closed.

4. Basic Operation

4.1 Restore the factory set operation

The following diagram shows the connections on the bottom of APsystems the ECU-C.



Figure 14

To restore the ECU-C's factory settings, simply press the "Reset" button for three seconds or longer. The unit will automatically return to its default settings.

5. EMA Manager

Please scan QR code below to have access to our products and APP catalogue, or click this link to download our APPs: <http://q-r.to/1OrC>.



- EMA Manager APP: for installers
 - Professional installers: all features available
 - DIY (Do It Yourself) installers: only ECU_APP features available
- EMA APP: for end-users only

5.1 Connecting to the ECU-C via the Local Wireless

- Open Wi-Fi setting in your smartphone, default no password.
- Open the EMA Manager.
- Click “**ECU APP**” to enter “**Local Control**”.

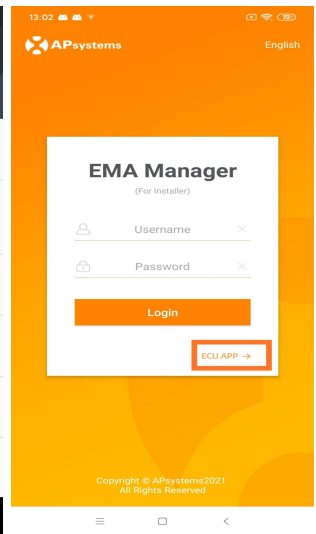
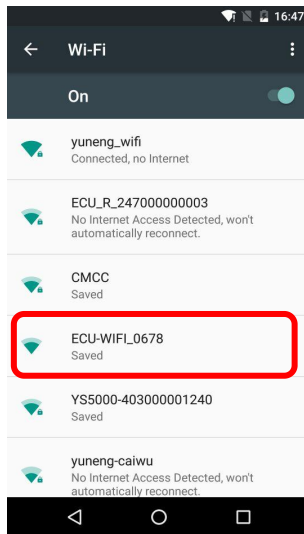
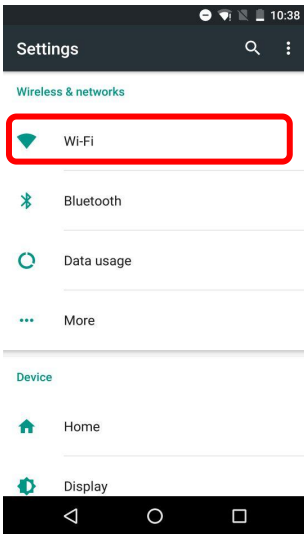

5.EMA Manager

5.2 Add UID

- Enter microinverters UID (serial numbers) into the ECU-C
Click “Workspace”, select “ID Management”, input the microinverters UID (serial number: 12 digits starting with a 4, a 5, a 7 or a 8) manually or scan the UID with your smartphone or tablet scanner. Once the microinverters UID have been entered, please press “Sync”.

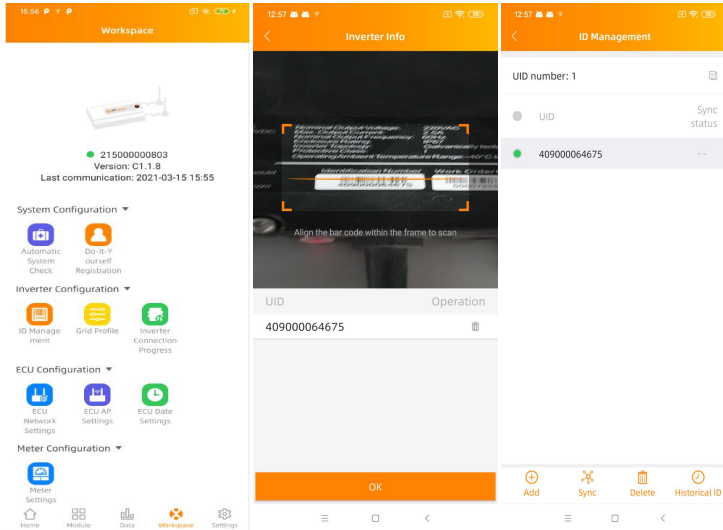

5.3 Historical ID

- If the ECU accidentally emptied the inverter list, you can use the same mobile phone to quickly restore the inverter id list.



5.EMA Manager

5.4 Delete UID

- In case of wrong entry or typo, select the microinverter UIDs, click “Delete” then click “Sync”. The selected UID(s) will be removed from the ECU-C.

Note: when deleting, please press also “Sync”. Otherwise the microinverter will not be removed from the ECU-C.

Once the microinverters UID have been successfully entered into the ECU-C, you need to select grid profile and define the adequate time zone of your ECU.

5.5 Grid Profile

- From the workspace, select “Grid profile”.
- First select country and then the city.

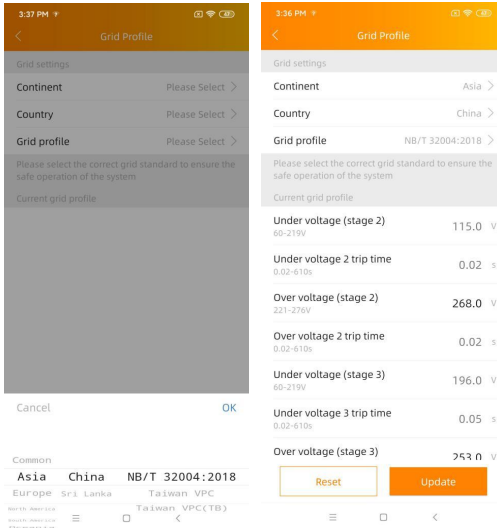

NOTICE

If you select the wrong grid profile, the microinverters may not start or may not produce as per optimal performance.

5.EMA Manager

5.6 Time management

- From the workspace, please select menu “ECU Date Settings” manual set-up, click “Date”, “Time” and “Timezone” to modify.
- Automated set-up: Click “Time quick setting”: the APP will synchronise on the time and time zone as per smartphone or tablet settings.

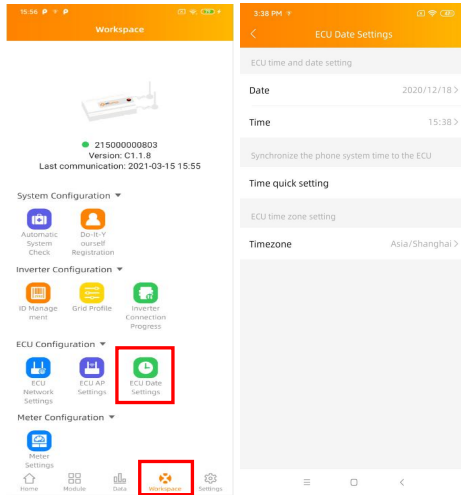

5.7 Meter Settings

- After the metering functions activated and CTs (current transformers) in place, the meter data will be displayed, and different control functions can be selected.

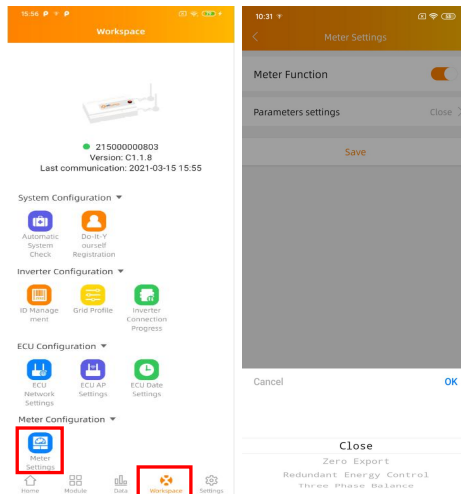

5.EMA Manager

5.7.1 Zero Export (only works with ECU-C in single phase and tri-phase systems)

Zero Export Function

- Only works with ECU-C in Single-phase and Three-phase systems
- Not compatible with Split-phase systems as commonly used in North American residential electrical service

Using the Zero Export function:

- Select 'Meter Settings'
- Slide the 'Meter Function' to the 'On' position
- Select 'Zero Export' in the slide menu at the bottom of the page and select OK
- After turning on the Zero Export Function, please set a Power Limit in kW. The default value is 0.

The ECU-C measures the array production and site consumption and will curtail power production to meet (or exceed if selected) the site consumption. Example: if the Power Limit is set to 0 and the site is using 10kW and the array is producing 8kW the inverters will operate at 100%. Conversely, if the Power Limit is set to 0 and the site is using 3kW and the array can produce 8kW the inverters will curtail power production to meet the demand. In addition, the ECU-C is designed to dynamically adjust to the changing demand of the site automatically in real-time to realize the full potential of the array.

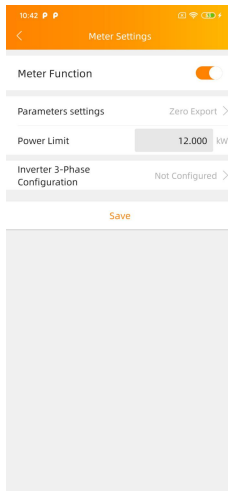

5.EMA Manager

5.7.2 Redundant Energy Control (only works with one single phase equipment)

Redundant Energy Control Feature

- Only works with ECU-C in Single-phase
- Cannot be combined with zero-export feature

Using the Redundant Energy Control function:

- Select 'Meter Settings'
- Slide the 'Meter Function' to the 'On' position
- Select the 'Redundant Energy Control' under 'Parameter settings'

This function is to control the opening of the external AC contactor by closing the ECU-C relay when the power of the uploaded power grid reaches a certain power value, to supply power to external electrical equipment e.g., water heater, pool pump, air conditioner, etc. Example: the power requirements of a water heater is 2kW, and the turn-on threshold can be set to 2kW, so when the array power exceeds 2KW, the water heater is powered by the relay control and does not consume grid power.

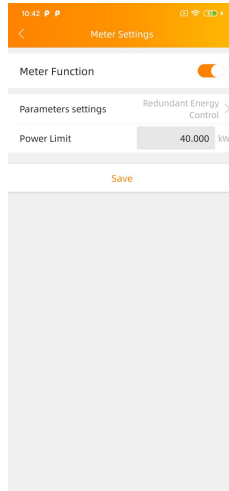

5.EMA Manager

5.7.3 Three-phase Balance

- When using APsystems single-phase micro-inverse to form a three-phase system, the three-phase balance function can be turned on to ensure that the three-phase current difference does not exceed 16A.
- The three-phase balance function can be connected to the detection current through an external CT, and the response speed is faster; it can also be collected by the ECU to collect micro-inverse data on each phase for detection. At this time, no external CT is required, but the response speed will be slow, and the general maximum duration is 5 minutes.
- And at this function, you need to register separately according to the micro-inverse serial number of each phase in the three-phase configuration.

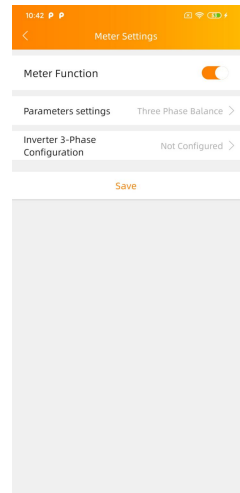

5.8 Modbus Settings

NOTICE

As shown in Figure 15 below, RS485 interface is located under the ECU. It can be connected by Serial line.

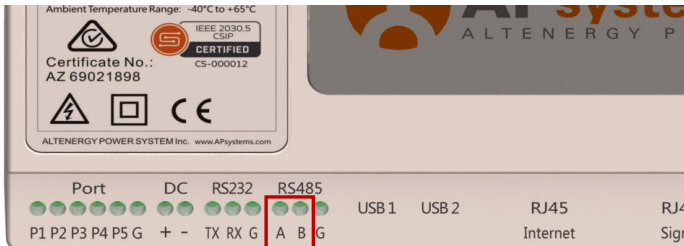

Figure 15

5.EMA Manager

For three-phase Microinverter: Please refer to the document Altenergy_Power_System_Inc.____three_phase_microinverter_11-12.xlsx on SunSpec website.

https://certifications.sunspec.org/PICS/Altenergy_Power_System_Inc.____three_phase_microinverter_11-12.xlsx

For single-phase Microinverter: Please refer to the document Altenergy_Power_System_Inc.____single_phase_MicroinverterAPpcs_11-12 on SunSpec website.

https://certifications.sunspec.org/PICS/Altenergy_Power_System_Inc.____single_phase_MicroinverterAPpcs_11-12.xlsx

- Click Modbus Settings in the Workspace, switch on the SunSpec Modbus function. Select the baud rate and configure Inverters ' address in the address text box. Finally, click Save to finish configuration.
- The host's RS485 port must be configured to the same baud rate, 8 data bits, 1 stop bit, none parity bit.

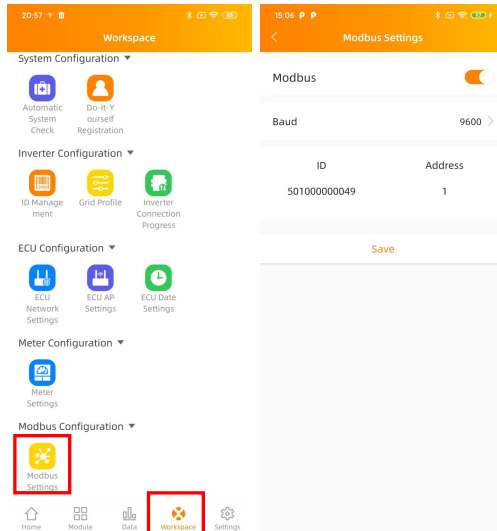

5.EMA Manager

5.9 ECU Network Settings

5.9.1 WLAN

- From the Workspace menu, select “ECU Network settings”.
- Swipe down the screen, the available SSIDs will be displayed .
- Select the network of your choice and enter its password.
- When connecting to the local Wifi, the smartphone or tablet may lose its connection to the ECU hotspot and connect to other wifi network or 4G.
- If more operations are needed to finish-up the ECU commissioning, please make sure to reconnect your smartphone or tablet to the ECU hotspot (may have to press the AP button to re-activate the hotspot).

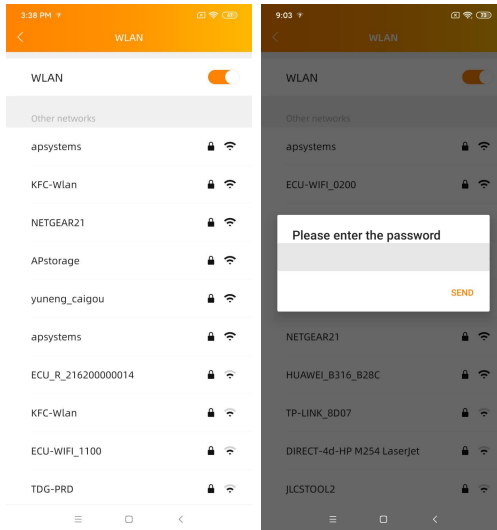

- When your smartphone or tablet is connected to the ECU hotspot again, you can open the ECU APP home page and check the internet connection status.
- The first bullet (with ECU UID) is green when the smartphone/tablet is properly connected to the ECU hotspot.
- The 2nd bullet shall be green if the internet connection to the router has been successfully established.

5.EMA Manager

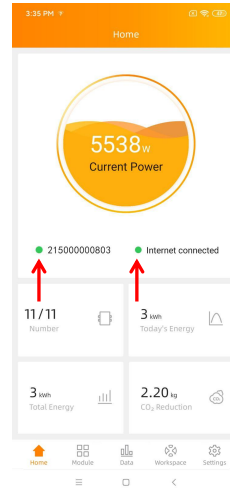

5.9.2 LAN

- Make sure the LAN cable is connected to the network port on the back of the ECU-C.
- Connect the LAN cable to a spare port on the broadband router.
- ECU's wired network setting has 2 options:
- automatically obtain an IP address: the router will give an IP address to the ECU-C automatically (preferred method) .
- use a fixed IP address. In that case, you need to enter enter IP address, subnet mask, default gateway, Preferred DNS server and Alternate DNS server.

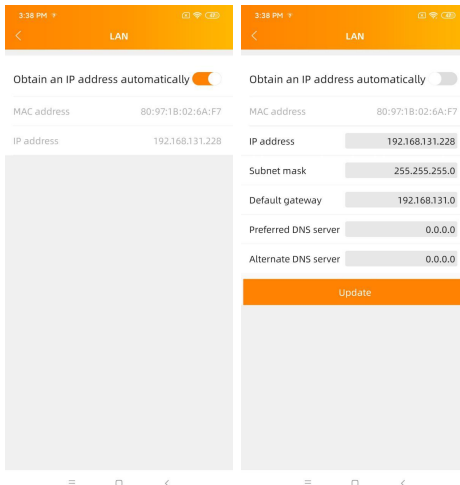

5.EMA Manager

- Once the LAN connection has been established, you can check the internet connection on the home page of the ECU APP:
- The first bullet (with ECU UID) is green when the smartphone/tablet is properly connected to the ECU hotspot.
- The 2nd bullet shall be green if the internet connection to the router has been successfully established.

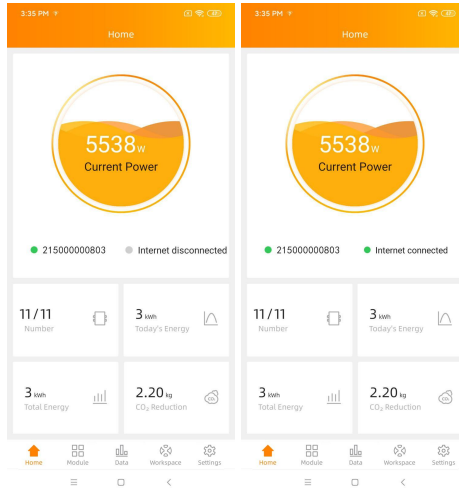

5.10 Checking the commissioning of the ECU-C

- Once the ECU-C has been commissioned, installer can check status on the home page of the ECU APP:
- Several infos are displayed
 - Systems info (ECU UID, serial number)
 - number of microinverters communicating with the ECU / total number of microinverters entered in the ECU (using the ID Management menu).

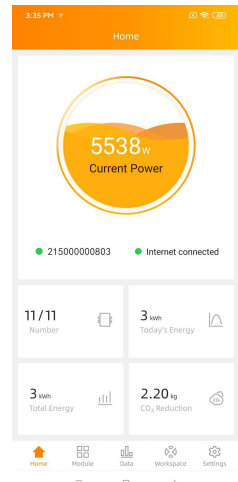

5.EMA Manager

- The light in front of the ECU UID shows the status between mobile phone and ECU:
 - -The mobile phone connects to the ECU.
 - -The mobile phone fails to connect to the ECU.
- The light in front of “Internet disconnected” shows the status between ECU and internet.
 - -The ECU connects to internet.
 - -The ECU fails to connect to the internet.

5.11 Module

- This page displays the microinverters entered in the ECU (via the Menu ID Management) and properly registered by the ECU.
A dual microinverter will be shown by default with 2 PV modules, while a quad microinverters will be shown by default with 4 PV modules.
if some DC channels are not connected on purpose, the ECU_APP will nonetheless continue to display the maximum number of panels which can be connected to a given microinverter.
- Removing un-used channel needs to be done from the EMA installer account when creating end-user account.
- On the module page, installer can visualize the performance of microinverters registered into the ECU.
- Click “Panel”: the detailed information of the microinverter is displayed, including inverter UID, PV module DC power, grid voltage, frequency and temperature.

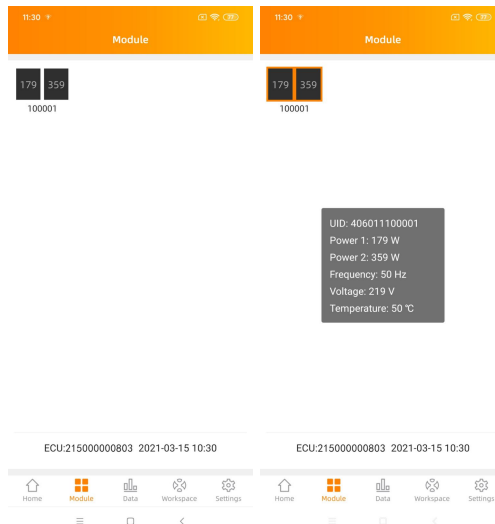

5.EMA Manager

5.12 Data

- In this page, you can view the detailed data on ECU level:
 - Per day
 - Per month

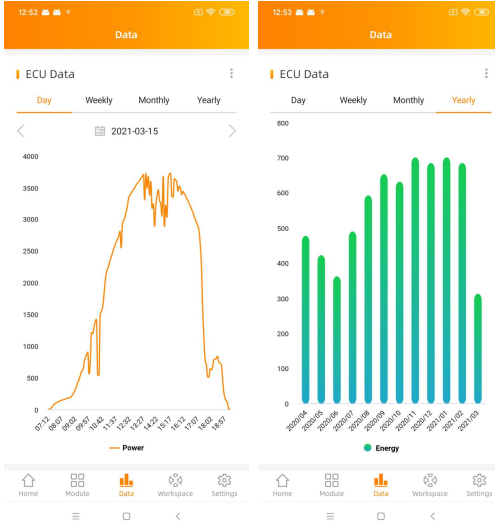

- If with metering functions activated and CTs (current transformers) in place, you can also visualize PV production, house-hold consumption and grid import/export data on meter level.

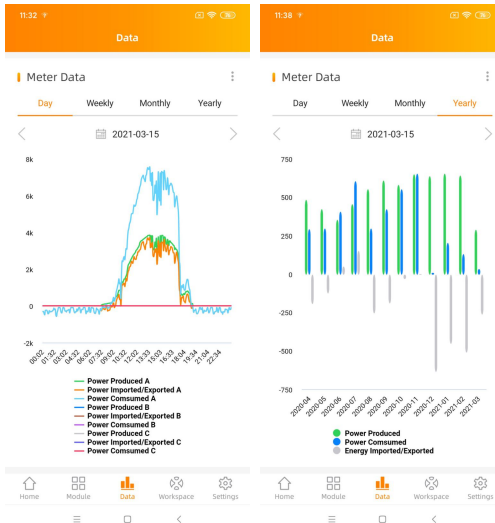

5.EMA Manager

5.13 Inverter Connection Progress

- This menu shows the connection progress and communication quality between microinverter and ECU, 100% means the connection is over.

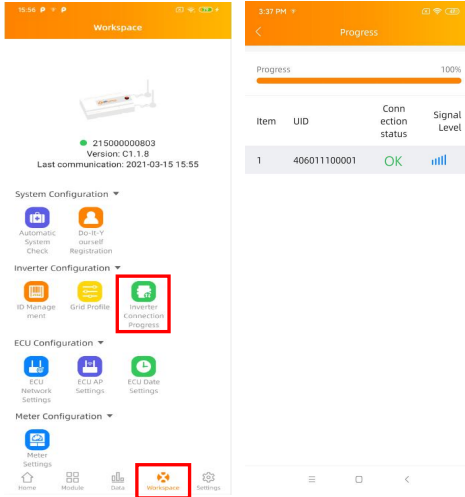

- The microinverters with "OK" are properly connected to the ECU

5.14 Automatic System Check

- Once the ECU has been commissioned, the menu "Automatic System Check" can help you to check proper communication and production of each microinverter.
- This menu also gives some basic troubleshooting tips.

5.EMA Manager

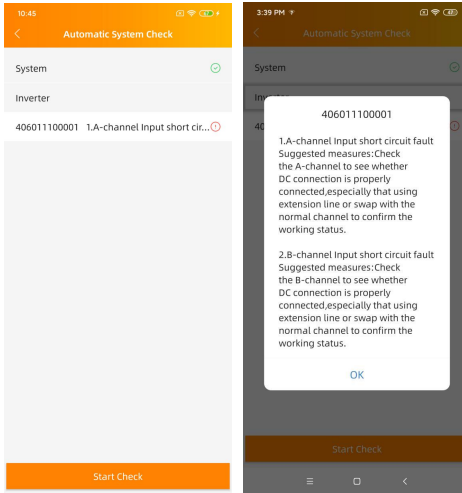

5.15 ECU AP Settings

- This menu can be used if you would like to change the default password of the ECU-C hotspot.
- Please connect to the ECU hotspot first, open the menu “ECU APP settings” and change the password at your convenience.
- If doing a reset of the ECU, password will be cleared.

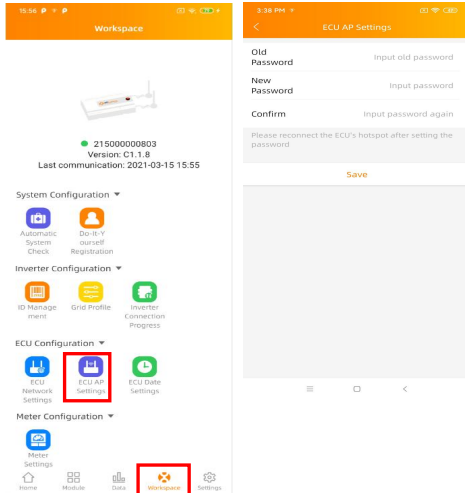

5.EMA Manager

5.16 Do-It-Yourself(DIY) Registration

- This menu is only for DIY installers: it will allow DIY installer to create their EMA account by themselves. They can later on access to their account via the EMA APP.
- Once the ECU has been properly commissioned, make sure to connect your smartphone or tablet to local internet.
- Enter “Do it Yourself Registration Menu” and follow instructions to create your own EMA account.

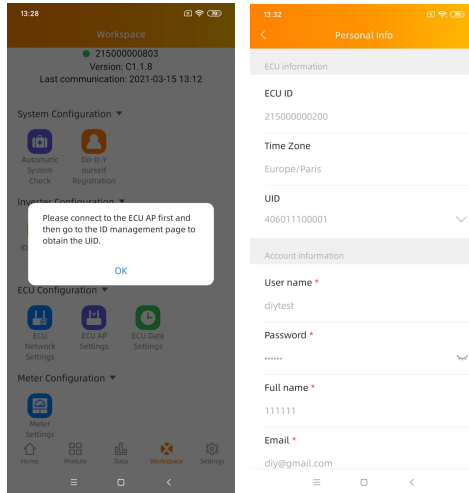

5.EMA Manager

5.17 Settings

- This basic menu allows you to change the Language: English, French, Spanish, Portuguese, Polish, Simplified Chinese and traditional Chinese. We're adapting to more languages.

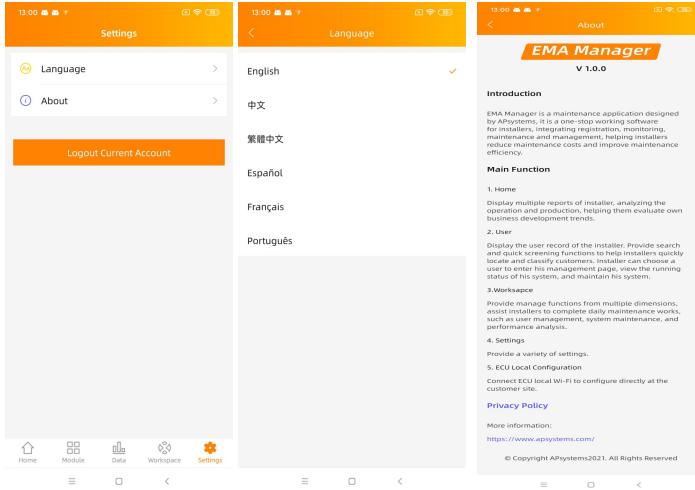

6. Local Network Interface

6.1 Connecting to the ECU-C via the Local Wireless

1. Turn on the Wi-Fi function on PC or phone.
2. Scan the ECU's SSID which named "ECU-WIFI_XXXX" (the "xxxx" refers to the last 4 numbers of the ECU-C ID), connect to the ECU-C's SSID. The first connection has no password.
3. Using a standard web browser on your computer, Enter the ECU's IP 172.30.1.1 into browser.

The ECU-C's "splash" screen is displayed.

English | Chinese

Home | Real Time Data | Administration | Advanced

Home	
ECU ID	215000000200
Lifetime generation	0.29 kWh
Last System Power	0 W
Generation of Current Day	0 kWh
Last Connection to website	2020-06-05 12:39:25
Number of Inverters	2
Last Number of Inverters Online	0
Current Software Version	C1.1
Current Time Zone	Asia/Taipei
ECU Eth0 Mac Address	80:97:1B:00:AC:E0
ECU Wlan0 Mac Address	60:C5:A8:E6:09:1C

2020-06-05 13:07:20
Friday

ENVIRONMENTAL BENEFITS

CO₂ Offset Equivalent to



	0	GALLONS
	0	TREES
	0	KG

Figure 15

6.2 Home Screen

Select "Home" at the top of the page. The Home Page is displayed.

English | Chinese

Home | Real Time Data | Administration | Advanced

Home	
ECU ID	215000000200
Lifetime generation	0.29 kWh
Last System Power	0 W
Generation of Current Day	0 kWh
Last Connection to website	2020-06-05 12:39:25
Number of Inverters	2
Last Number of Inverters Online	0
Current Software Version	C1.1
Current Time Zone	Asia/Taipei
ECU Eth0 Mac Address	80:97:1B:00:AC:E0
ECU Wlan0 Mac Address	60:C5:A8:E6:09:1C

2020-06-05 13:07:20
Friday

ENVIRONMENTAL BENEFITS

CO₂ Offset Equivalent to

	0	GALLONS
	0	TREES
	0	KG

Figure 16

6. Local Network Interface

ECU-C ID:	This is a unique number that identifies this specific ECU-C.
Lifetime Generation:	Amount of power this system has generated during its lifetime.
Last System Power:	Amount of power the system was generating during its last polling cycle.
Generation of Current Day:	Amount of power that has been generated during the most current day.
Last connection to Website:	The last time the ECU-C checked into the central APsystems EMA database.
Number of Inverters:	Number of inverters that have programmed into the ECU-C.
Last Number of Inverters Online:	Number of inverters that are checking in with the ECU-C.
Current Software Version:	Current version of the firmware.
Current Timezone:	Time zone that has been programmed into the ECU-C.
ECU-C Eth0 Mac Address:	Address of ECU-C's LAN.
ECU-C Wlan0 Mac Address:	Address of the ECU-C's internal WLAN.
Inverter Comm. Signal Level:	The communication strength between inverters and ECU-C. The range is 1-5, the higher the better.

6. Local Network Interface

6.3 Real-time Data Screen



ENERGY COMMUNICATION UNIT

English | Chinese

Home | **Real Time Data** | Administration | Advanced

Real Time Data

Inverter ID	Current Power	Grid Frequency	Grid Voltage	Temperature	Reporting Time
409000064675-1	-	-	-	-	2020-06-05 12:59:59
409000064675-2	-	-	-	-	
536000000028-1	-	-	-	-	
536000000028-2	-	-	-	-	2020-06-05 12:59:59

Real Time Data

- Power
- Energy

Figure 17

a) Real Time Data

To view the real-time system operation data statistics for your solar array, click “Real Time Data” from the ECU-C home screen to navigate to the real-time data screen.

b) Trend of system power

To view the system power of any period, click “Power” at the real-time data page.

c) Power generation statistics

Press “Energy” at the real-time data page to view the system power generation of your solar array. Performance data for the current week/month/year.

6.4 Administration Screen



ENERGY COMMUNICATION UNIT

English | Chinese

Home | Real Time Data | **Administration** | Advanced

ID Management

409000064675
536000000028

Three Phase Configuration

ID Management

- Grid Profile
- Date,Time,Time Zone
- Language
- Network Connectivity
- WLAN
- Firmware Update

Note if a three-phase system composed of APsystems's single-phase micro-inverters needs to realize the function of independent anti-backflow of each phase or limit the grid power or three phase balance or extended phase symmetry, it is necessary to register the micro-inverters connected to each phase separately in the corresponding boxes.

Figure 18

6. Local Network Interface

a) Managing Inverter IDs

The inverter IDs must be programmed into the ECU-C for the ECU-C to recognize the inverters. The ECU-C will NOT auto-sense the inverters.

Initial Programming of the ECU-C with the Inverter IDs.



NOTICE

The “Enter Inverter ID” window field will be blank if you have not yet entered any of the inverter IDs.

Select “Administration” at the top of the page. The ID Management page is displayed.

User can modify the ids in the text box to add, delete or replace ids.



NOTICE

Combine the above two steps when swapping out an inverter. Add the new inverter, and Delete the old one. Remember to follow up with the same process on the APsystems EMA because the ECU-C and EMA need to be in sync with each other.

b) Grid Profile

User needs to select grid profile when installing the system.



NOTICE

If you select the wrong grid profile, the inverters will not work normally.

c) Changing the Date, Time Zone

It is critical for accurate power production reporting that the ECU-C is programmed with the correct date, time, and time zone.

- 1) Select “Administration” at the top of the page.
- 2) Select “Date, Time, Timezone”.
- 3) Adjust the correct date in the “Date Time” field.
- 4) Select the correct time zone from the Time Zone pull down.



NOTICE

You can skip step 3 by selecting the correct time zone. Selecting the correct time zone automatically updates both the date and current time.

6. Local Network Interface

d) Changing the Language

Users can switch language between English and Chinese.

- 1) Select “Administration” at the top of the page.
- 2) Select “Language”.
- 3) Select the language from the Current Language pull down.
- 4) Press “Update”.

e) Managing the Network Connection

The default network connection setting for the ECU-C is “DHCP,” which allows the ECU-C to automatically establish a connection assignment from the router. The ECU-C can be assigned a static.

IP Address if the network design requires it.

- 1) Select “Administration” at the top of the page.
- 2) Select “Network Connectivity”.
- 3) Select “Obtain an IP address automatically”.
- 4) Press “Update”.

f) Managing the WLAN connection

The ECU-C can both work in two modes: WLAN and Local Wireless Access. In WLAN mode, the ECU-C can connect to a router by Wi-Fi. In Local Wireless Access mode, user’s phone or PC can connect to ECU-C to access local web.



NOTICE

Static IP mode and WLAN mode cannot be used at the same time.

WLAN mode

- 1) Select “Administration” at the top of the page.
- 2) Select “WLAN”, and click “WLAN” tab.
- 3) The ECU-C will display the available networks. Select the button next to the available network that you wish to access SSID, and a password entry field will be displayed below the network name. Enter the password into the password entry field, then click “Connect”.
- 4) If ECU-C has connected to the router, it will display the SSID and IP address. Now you can connect by PC or phone to the router. Enter the ECU-C’s IP (e.g., 192.168.4.119) into the browser to access the local web.

Local Wireless Access mode

- 1) Scan the ECU-C’s SSID on PC and phone, and connect to ECU-C. Enter the ECU-C’s IP 172.30.1.1(The IP is fixed) into browser to access the local web.

6. Local Network Interface

- 2) On the page, you can modify SSID, Channel, Safe Type and Password. If you don't select the Safe Type, the Password is hidden.

g) Firmware Update

Select the ECU-C upgrade package, and click OK to upgrade ECU-C firmware.

The upgrade package can be downloaded at www.APsystems.com.

6.5 Advanced Screen

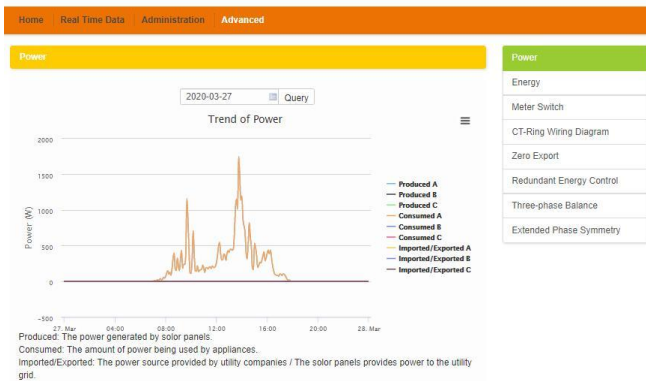

Figure 19

a) Trend of power

To view the production power, consumption power and exported power of any period, click "Power" at the "Advanced" page.

b) Energy statistics

Press "Energy" at the "Advanced" page to view the production energy, consumption energy and exported energy. The energy statistics screen is displayed. Performance data for the week/month/year.

c) Meter Switch

Once the meter display is turned on, ECU will refresh the meter data every 5 minutes.

d) CT-Ring Wiring Diagram

Please refer the pictures on the ECU's page to install CTs.

User needs to install six CTs in three-phase system, or install two CTs(1A,2A) in single-phase system.

6. Local Network Interface

e) zero export

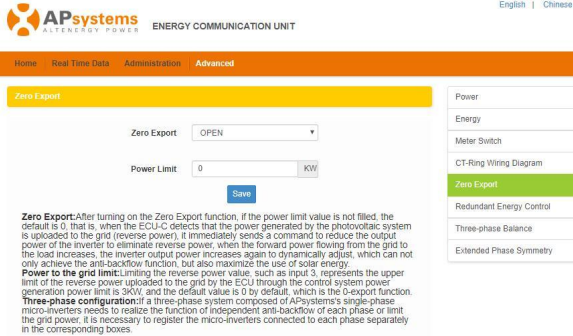

Figure 20

The zero export function could limit the power export to the grid. Users could set the maximum export power when the zero export function is turned on.

After turning on the Zero Export function, if the power limit value is not filled, the default is 0, that is, when the ECU-C detects that the power generated by the photovoltaic system is uploaded to the grid (reverse power), it immediately sends a command to reduce the output power of the inverter to eliminate reverse power, when the forward power flowing from the grid to the load increases, the inverter output power increases again to dynamically adjust, which can not only achieve the anti-backflow function, but also maximize the use of solar energy.

NOTICE

Only for single phase and three phase grid application, not for US/Canada split phase.

f) Redundant energy control

The redundant energy function enables excess energy produced by the PV system to be directed towards some dedicated electrical equipment by activating a relay. When the excess energy is more than the set threshold, ECU-C will close the relay.

NOTICE

Only for single phase grid application.

g) Three-phase balance

Three Phase Balance function could limit the current between each phase less than 16A. User needs to click the "three phase configure" button to bind the inverters into corresponding phase.

h) Extended Phase Symmetry

When using APsystems single-phase micro-inverse to form a three-phase system, if one phase's AC breaker is tripped or switched off, the inverters on this phase will shutdown, and then the inverters on the other 2 phases also will be turned off, until the AC breaker is turned on, all the inverters will start again.

7.Remote ECU-C Management (EMA)

The ECU-C has been designed with remote connect functionality. You can access this remote functionality through the APsystems Energy Monitoring & Analysis (EMA) website, using your installer login credentials. Changes made remotely through the EMA do not take effect until the ECU-C's next reporting cycle.

The ECU-C must first be installed with Internet connectivity.

The ECU-C remote functionality allows you to do the following:

- Set Time Zones
- Manage Inverter IDs

There are additional ECU-C functions available but the instructions are not outlined in this document. If you need to access one of the following features, please contact APsystems Technical Support:

- Change system parameters
- Turn the inverters ON and OFF
- Reset GFDI
- Reset Power Settings



NOTICE

This section of the documentation assumes you have a working knowledge of the APsystems EMA.

- 1) Log onto your APsystems EMA account. Your Customer List within the Installer Portal is displayed.
- 2) Select the customer's ECU-C you want to manage and click on the username in the "Customer Account" column.

ID	Customer Account	ECU ID	Title Name	Country	State	City	System Size(KW)	Register Date	System Status	Action
1	ctrlor	203000014617	Mike	United States	WA	La Center		2015-11-18		Delete
2	Stevens Langer	203000024740	Stevens Langer	United States	WA	Camas	8	2015-11-10		Delete
3	NickDrouin	203000006557	Nicolas Drouin	United States	WA	Bellevue	10.0	2015-05-05		Delete
4	passner	203000015787	Paul Usher	United States	NY	Smithtown	5	2015-01-31		Delete
5	dkszcz	203000016109	Don Kleszcz	United States	CA	Camarillo		2014-12-24		Delete
6	ethomason	203000012880	Earl Thomason	United States	WA	Vancouver	7.5	2014-11-14		Delete
7	jlopez	203000014540	Jaime Lopez	United States	CA	South Gate		2014-10-07		Delete
8	Schieff	203000014624	Phil Schieff	United States	CA	Newbury Park	8.25	2014-10-03		Delete
9	Ribic	203000012735	Rachael Ribic	United States	WA	Spokane	3.3	2014-06-20		Delete
10	PVUSA	203000008668	Steve Coonen	United States	California	Davis		2014-02-07		Delete

Figure 21

7.Remote ECU-C Management (EMA)

7.1 ECU-C Configuration/ECU-C Status Page

ECU-C SETTING page under the Remote control page.

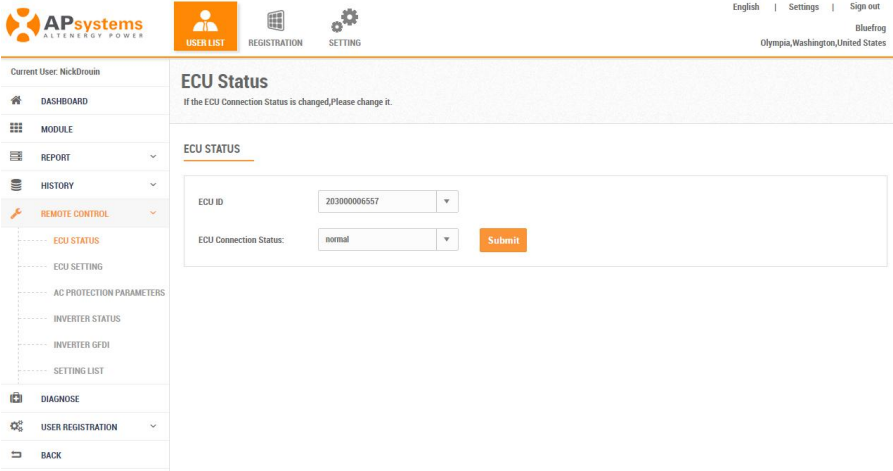

Figure 22

The ECU-C SETTING tab allows you to:

Set Time Zones

- The ECU-C time zone can be set or adjusted remotely through the ECU-C setting tab. If the time zone is not properly set, the solar production data will not post properly on the EMA site.

Load Inverter IDs

- Once the ECU-C has been installed you can access the ECU-C remotely to add the inverter IDs. Until the inverter IDs are loaded, the ECU-C will not be able to collect data from the inverters.

Update Inverter ID list

- If an inverter(s) is added or swapped for a new unit, then the ECU-C's programmed list of inverters will need to be updated.

7.Remote ECU-C Management (EMA)

7.2 Setting the ECU-C Time Zone

- 1) Click the remote control menu to enter the remote settings page
- 2) Select the “ECU-C SETTING” tab.

The ECU-C Configuration page is displayed.

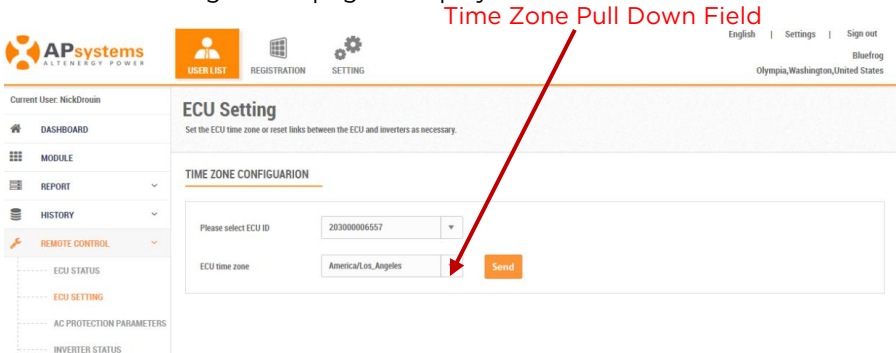

Figure 23

- 3) Using the “Time Zone” pull down field, select the appropriate time zone.
- 4) Press “Send”.

7.3 Managing Inverter IDs and Updating the Inverter ID List

- 1) Select the “ECU-C SETTING” tab.

The Inverter Links Configuration page is displayed

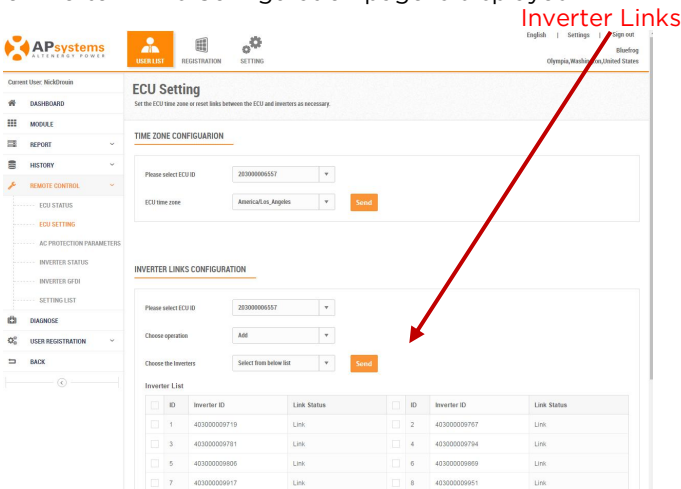

Figure 24

7.Remote ECU-C Management (EMA)

Operation Selection (Add or Delete)

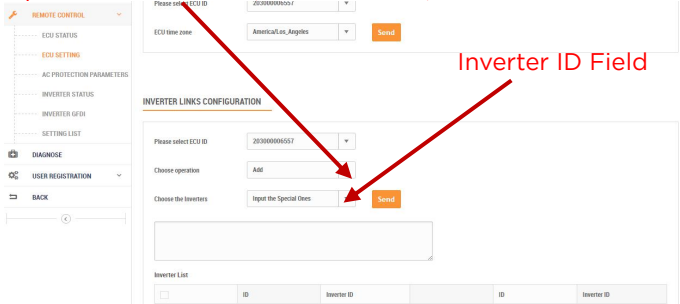

Figure 25

Adding Complete List of Inverter IDs for a Newly Installed System
There are two different approaches to add the inverter IDs:

Option 1: Webpage -

1. Select Add inverter based on registration list
 - 1) Select “Add” in Operation Selection.
 - 2) Select the Inverters“select from below list”.
 - 3) Select the inverter to be added
 - 4) Press “Send”.
2. The specified inverter ID
 - 1) Select “Add” in Operation Selection.
 - 2) Select the Inverters“input the special ones”.
 - 3) Enter all of the inverter IDs into the Inverter ID Field(one per line).
 - 4) Press “Send”.

Option 2: Mobile phone-

- 1) Log onto ArrayAPP.
- 2) Select user account.
- 3) Select Link ECU.
- 4) Press “Send”.

Delete IDs from Inverter List

1. Select Delete inverter based on registration list
 - 1) Select “Delete” in Operation Selection.
 - 2) Select the Inverters“select from below list”.
 - 3) Select the inverter to be deleted.
 - 4) Press “Send”.
2. The specified inverter ID
 - 1) Select “Delete” in Operation Selection
 - 2) Select the Inverters“input the special ones”.
 - 3) Enter all of the inverter IDs into the Inverter ID Field(one per line).
 - 4) Press “Send”.
3. Delete all
 - 1) Select “Clear” in Operation Selection.
 - 2) Press “Send”.

8. Technical Data

Communication Interface

Communication Method	ZigBee
Integrated Wi-Fi	802.11g/n
Ethernet	10/100M Auto-sensing, Auto-negotiation
USB Interface	5Vdc-0.5A Output X2
RS232	Standard
RS485	Standard
RJ45	Standard

Power Supply

AC Power Supply	110-277VAC, 50-60Hz Single Phase -(3-Phase Optional)
DC Power Supply	12-16V
Power Consumption	3W

Mechanical Data

Dimensions (W×H×D)	210 x 120 x 41mm (8.3" x 4.7" x 1.6")
Weight	500g (1.1lbs)
Ambient Temperature Range	-40°C to +65°C (-40°F to 149°F)
Cooling	Nature Convection; No Fans
Enclosure Environmental Rating	Indoor - IP20 (NEMA 1)

Other Features

Maximum Communicating Inverter Qty	120
Grid Type	Single Phase/ Three Phase
Relay Driver	Control external AC contact or relay
Relay Feedback	Get relay signal, could do anti-backflow control, and energy management
Digital Input	For external control device connection
CT Sensor	Production and consumption metering
Meter Accuracy	Integrated PV production metering (+/- 0.5% via CT) and optional consumption monitoring (+/- 2.5% via CT)

Compliance

Compliance	IEC/EN61010-1, EN61000-6-1, EN61000-6-2, EN61000-6-3, EN61000-6-4, 2014/30/EU, EN301489-1/-17, EN62479, EN 300328
------------	---

Specifications subject to change without notice.

Please ensure you are using the most recent update found at www.APsystems.com.

8. Technical Data

:: **WEEE** (for Europe)



Disposal of your old appliance

1. When this crossed-out wheeled bin symbol is attached to a product, it means the product is covered by the European Directive 2002/96/EC.
2. All electrical and electronic products should be disposed of separately from the municipal waste stream via designated collection facilities appointed by the government or the local authorities.
3. The correct disposal of your old appliance will help prevent potential negative consequences for the environment and human health.
4. For more detailed information about disposal of your old appliance, please contact your city office, waste disposal service or the shop where you purchased the product.

Contact Information

ALTENERGY POWER SYSTEM Inc.

www.APsystems.com

APsystems Jiaxing China

No. 1, Yatai Road, Nanhu District, Jiaxing, Zhejiang

Tel: +86 573 8398 6967

Mail: info@altenergy-power.com

APsystems Shanghai China

Rm.B305 No.188, Zhangyang Road, Pudong, Shanghai 200120,P.R.C

Tel: 021-3392-8205

Mail: info.global@APsystems.com

APsystems Guadalajara:

AV. Lazaro Cardenas 2850-5º Piso, Colonia Jardines del Bosque C.P. 44520, Guadalajara, Jalisco

Tel:52 (33) -3188-4604

Mail: info.latam@APsystems.com

APsystems America

600 Ericksen Ave NE, Suite 200 Seattle, WA 98110

Tel: 844-666-7035

Mail: info.usa@APsystems.com

APsystems Australia

Suite 502, 8 Help Street, Chatswood NSW 2067 Australia

Tel: 61 (0)2-8034-6587

Mail: info.apac@APsystems.com

APsystems Europe

Cypresbaan 7, 2908 LT,Capelle aan den IJssel The Netherlands

Tel: +31-10-2582670

Mail: info.emea@APsystems.com

APsystems EMEA

Rue des Monts dor ZAC de Foliieuses Sud-Les Echets 01700 Miribel, France

Tel: +33-481-65-60-40

Mail: info.emea@APsystems.com