

ANNEX TO THE CERTIFICATE

2621/0015-E3-CER

Important Note :

- This document is issued by the Company under its General Conditions of service accessible at http://www.sgs.com/terms_and_conditions.htm. Attention is drawn to the limitation of liability, indemnification and jurisdiction issues defined therein. Any holder of this document is advised that information contained hereon reflects the Company's findings at the time of its intervention only and within the limits of Client's instructions, if any. The Company's sole responsibility is to its Client and this document does not exonerate parties to a transaction from exercising all their rights and obligations under the transaction documents.
- Any unauthorized alteration, forgery or falsification of the content or appearance of this document is unlawful, and offenders may be prosecuted to the fullest extent of the law.
- Unless otherwise stated the results shown in this document refer only to the sample(s) tested as received. The Company SGS shall not be liable for any incorrect results arising from unclear, erroneous, incomplete, misleading, or false information provided by Client. This document cannot be reproduced except in full, without prior approval of the Company.

Document Historical Revision:

Document Version	Date	Resume
Revision 0	28/01/2021	First issuance
Revision 1	01/06/2021	This document is modified to add information about the transferability of the validation process according to FGW TG4 to derived models, SG33CX and SG40CX. Further editorial changes have been added.
Revision 2	17/08/2021	This document is modified in order to evaluate new updates in TG3 and TG4 reports after new tests and simulations have been respectively performed to evidence the transferability of the certification process to derived models, SG33CX and SG40CX. Further editorial changes have been added.
Revision 3	21/01/2022	The annex is modified as manufacturer has updated the Dynamic Simulation Model to version 3.2 to prevent the total current from exceeding the limit due to the output of negative sequence active current in case of some unbalanced faults.

		<p>Added clause 3.1.3 to show which tests have been repeated and verify that updated model has not critical change to the previous version model</p> <p>The ISO 9001 Quality Management System Certificate of one of the manufacturers was updated because the current certificate was expired</p> <p>Manufacture corresponds to Sungrow Developers (India) Private Limited</p> <p>Further editorial changes are included</p>
--	--	---

This document is created based on requirements of FGW Technical Guidelines for Power Generating Units, Systems and Storage Systems as well as for their Components. Part 8 (TG8). Certification of the Electrical Characteristics of Power Generating Units, Systems and Storage Systems as well as their Components on the Grid. Revision 09. Dated 01/02/2019.



INDEX

1	OVERVIEW OF THE FGW TR8 EVALUATION REPORT	4
1.1	INFORMATION ABOUT THE TESTED MODEL	5
1.2	INFORMATION ABOUT VARIANT MODELS TO BE INCLUDED INTO THE SCOPE OF THE CERTIFICATION PROCESS.....	9
1.3	SUMMARY OF THE EVALUATION OF THE TEST RESULTS	10
1.4	SUMMARY OF THE EVALUATION OF THE VALIDATION RESULTS	21
1.5	EVALUATION OF THE ISO 9001 QUALITY MANAGEMENT SYSTEM CERTIFICATE OF MANUFACTURERS... ..	24
1.6	COMPROMISE LETTER TO MAINTAIN ISO 9001 DURING THE VALIDITY PERIOD OF CERTIFICATE	27
1.7	COMPROMISE LETTER OF THE CERTIFIED PRODUCT.....	28
2	OVERVIEW OF RESULTS OF THE FGW TR3 TEST REPORT	29
2.1	NENNDATEN / RATED DATA:.....	29
2.2	POWER QUALITY.....	30
2.2.1	Wirkleistungsspitzen / Power Peaks.....	30
2.2.2	Schalhandlungen / Switching Operation	31
2.2.3	Unsymmetrie / Unbalances	32
2.2.4	Flicker	33
2.2.5	Oberschwingungsmessungen / Harmonics	39
2.2.6	Zwischenharmonische / Interharmonics	42
2.2.7	Höhere Frequenzen / Higher Frequencies components.....	45
2.3	GRID CONTROL CAPABILITY	48
2.3.1	Wirkleistungs einspeisung in Abhängigkeit der Netzfrequenz / Active power vs frequency ...	48
2.3.2	Procedure for reactive power provision.....	51
2.3.3	Blindleistungsbereitstellung / Provision of reactive power	52
2.4	PROTECTION SYSTEM	64
2.4.1	Trennung der EZE vom Netz / Cut-off from grid.....	64
2.4.2	Zuschaltbedingungen / Cut-in conditions.....	65
2.4.3	Zuschaltbedingungen nach Auslösung des Entkopplungsschutzes / Cut-in conditions after tripping of protection	65
2.5	RESPONSE DURING GRID FAULTS	66
3	OVERVIEW OF RESULTS OF THE FGW TR4 VALIDATION REPORT.....	67
3.1	VALIDATION RESULTS.....	69
3.1.1	Validation overview	69
3.1.2	Simulation results of Voltage-Dependent PQ diagrams of certified models	73
3.2	VALIDATION CONCLUSION	77
4	TECHNICAL DATA.....	78
4.1	TECHNICAL DATA.....	78
4.2	OVERVIEW OF IMPORTANT PARAMETERS OF THE GENERATION UNIT	79
4.3	ELECTRIC SCHEME.....	88
4.4	INTERFACES	89
4.5	MANUFACTURER'S CERTIFICATES FOR CERTIFIED PGUS ACCORDING TO FGW TG3	91
4.6	BEHAVIOUR IN THE EVENT OF A FAILURE OF EITHER THE PGP CONTROLLER OR THE ASSOCIATED MEASUREMENT OR THE CONNECTION BETWEEN PGP CONTROLLER AND PGU	92
5	DYNAMIC SIMUALTION MODEL INFORMATION	94
5.1	SOFTWARE CHARACTERISTICS.....	94
5.2	SOFTWARE INFORMATION AND COMMENTS	94
5.3	DESCRIPTION OF THE MODEL.....	96

1 OVERVIEW OF THE FGW TR8 EVALUATION REPORT

This point of this annex of the certificate no. 2621 / 0015 – E3 – CER contains the information of all items and documentation used for the evaluation of compliance of the certified product according to standards VDE-AR-N 4110: 2018-11, FGW-Richlinie TR 3 Rev. 25 (including supplement 1, dated on 22/01/2019) and FGW-Richlinie TR 4 Rev. 9.

The information contained in this point is extracted from the SGS Evaluation Report Number: 2621 / 0015, rev 2. With date on 21-01-2022 according of FGW TR8 rev. 9.

The evaluation performed by SGS comprises the checking in compliance with following requirements:

Evaluation:	Remarks	Result		
Keys: P.....Pass. NC.....Not Comply NA.....Not Applicable				
Checking of the PGU tested	See point 1.1 of this document	<input checked="" type="checkbox"/> P	<input type="checkbox"/> NC	<input type="checkbox"/> NA
Checking of the variant models to be included in the certification process	See point 1.2 of this document	<input checked="" type="checkbox"/> P	<input type="checkbox"/> NC	<input type="checkbox"/> NA
Review Test Report according FGW TG3 per VDE-AR-N 4110: 2018 certification	See point 1.3 of this document	<input checked="" type="checkbox"/> P	<input type="checkbox"/> NC	<input type="checkbox"/> NA
Review Test Report according FGW TG3 per VDE-AR-N 4120: 2018 certification	--	<input type="checkbox"/> P	<input type="checkbox"/> NC	<input checked="" type="checkbox"/> NA
Review Test Report according FGW TG4.	See point 1.4 of this document	<input checked="" type="checkbox"/> P	<input type="checkbox"/> NC	<input type="checkbox"/> NA
Quality system certificate according ISO 9001	See point 1.5 of this document	<input checked="" type="checkbox"/> P	<input type="checkbox"/> NC	<input type="checkbox"/> NA
Compromise letter of maintain ISO 9001 certified during the validity period of VDE certificate.	See point 1.6 of this document	<input checked="" type="checkbox"/> P	<input type="checkbox"/> NC	<input type="checkbox"/> NA
Compromise letter of product to certify is the same that the product tested, and transferability acceptance of non-tested PGU.	See point 1.7 of this document	<input checked="" type="checkbox"/> P	<input type="checkbox"/> NC	<input type="checkbox"/> NA

1.1 Information about the tested model.

Information appearing in the application form (CPR1FRM5):

- **Date of the application form:** 15/12/2020
- **Applicant:** Sungrow Power Supply Co., Ltd
- **License holder:** Sungrow Power Supply Co., Ltd
- **Factories:**
 1. Sungrow Power Supply Co., Ltd
Address: No.1699 Xiyou Rd.,New & High Technology Industrial Development Zone, Hefei 230088 P.R. China
 2. Sungrow Power Supply Co., Ltd.
Address: No. 608 Changning Avenue, New & High Technology Industrial Development Zone, Hefei 230088 P.R. China.
 3. Sungrow Developers (India) Private Limited.
Address: No. 85, Kaniminike village, Kengeri hobli Bangalore South Taluk, 560074 Bangalore, India
- **Product:**
 - Type: PV inverter
 - Trademark: Sungrow
 - Base model: SG50CX
 - Input ratings: 200~1000Vdc MPPT (1100Vmax.), 5*26A
 - Output ratings: 3/N/PE 400/230V, 50Hz, 72.5A(*)@50KW rated, 83.6A@55KVA max.
 - Software Version: LCD_AGATE-S_V11_V01_A , MDSP_AGATE-S_V11_V01_A
 - Variant models: SG40CX and SG33CX

Certification service applied:

Certification of PV Inverter according to VDE-AR-N 4110: 2018-11.

Information appearing in the test report according to FGW TG3:

- **Manufacturer:** SUNGROW POWER SUPPLY CO., LTD
- **Product:**
 - Type: Three phase grid connected PV inverter
 - Trademark: SUNGROW
 - Base model: SG50CX.
 - Input ratings: 200~1000Vdc MPPT (1100Vmax.), 5*26A
 - Output ratings: 3/N/PE 400/230V, 50Hz, 72.5A(*)@50KW rated, 83.6A@55KVA max.
 - Software Version: LCD_AGATE-S_V11_V01_A / MDSP_AGATE-S_V11_V01_A.
 - Serial number: A1906114188
 - Variant models: SG40CX and SG33CX

Revision 1. Dated on 01/06/2021.

A new application form is received on 01/06/2021 for the update of the certificate no. 2621/0015-CER. The reason of the update is to add information about the transferability to derived models, SG33CX and SG 40CX, of the validation process of the dynamic simulation model of SG50CX which completed according to FGW TG4 (Revision 9).

Information appearing in the application form (CPR1FRM5):

- **Date of the application form:** 01/06/2021
- **Applicant:** Sungrow Power Supply Co., Ltd
- **License holder:** Sungrow Power Supply Co., Ltd
- **Factories:**
 1. Sungrow Power Supply Co., Ltd
Address: No.1699 Xiyou Rd.,New & High Technology Industrial Development Zone, Hefei 230088 P.R. China
 2. Sungrow Power Supply Co., Ltd.
Address: No. 608 Changning Avenue, New & High Technology Industrial Development Zone, Hefei 230088 P.R. China.
 3. Sungrow Developers (India) Private Limited.
Address: No. 85, Kaniminike village, Kengeri hobli Bangalore South Taluk, 560074 Bangalore, India
- **Product:**
 - Type: PV inverter
 - Trademark: Sungrow
 - Base model: SG50CX
 - Input ratings: 200~1000Vdc MPPT (1100Vmax.), 5*26A
 - Output ratings: 3/N/PE 400/230V, 50Hz, 72.5A(*)@50KW rated, 83.6A@55KVA max.
 - Software Version: LCD_AGATE-S_V11_V01_A , MDSP_AGATE-S_V11_V01_A
 - Variant models: SG40CX and SG33CX

Certification service applied:

Certification of PV Inverter according to VDE-AR-N 4110: 2018-11.

Revision 2. Dated on 17/08/2021.

A new application form is received for the update of the certificate no. 2621/0015-E1-CER. The reason of the update is the update of the reports according to FGW TG3 and FGW TG4 to add respectively new tests and simulation results in order to evidence the transferability of the certification process to derived models, SG33CX and SG40CX.

Information appearing in the application form (CPR1FRM5):

- **Date of the application form:** 01/06/2021
- **Applicant:** Sungrow Power Supply Co., Ltd
- **License holder:** Sungrow Power Supply Co., Ltd
- **Factories:**
 1. Sungrow Power Supply Co., Ltd
Address: No.1699 Xiyou Rd.,New & High Technology Industrial Development Zone, Hefei 230088 P.R. China
 2. Sungrow Power Supply Co., Ltd.
Address: No. 608 Changning Avenue, New & High Technology Industrial Development Zone, Hefei 230088 P.R. China.
 3. Sungrow Developers (India) Private Limited.
Address: No. 85, Kaniminike village, Kengeri hobli Bangalore South Taluk, 560074 Bangalore, India
- **Product:**
 - Type: PV inverter
 - Trademark: Sungrow
 - Base model: SG50CX
 - Input ratings: 200~1000Vdc MPPT (1100Vmax.), 5*26A
 - Output ratings: 3/N/PE 400/230V, 50Hz, 72.5A(*)@50KW rated, 83.6A@55KVA max.
 - Software Version: LCD_AGATE-S_V11_V01_A , MDSP_AGATE-S_V11_V01_A
 - Variant models: SG40CX and SG33CX

Certification service applied:

Certification of PV Inverter according to VDE-AR-N 4110: 2018-11.

Revision 3

A new application form is received on 16/12/2021 for the update of the certificate no. 2619/0015-E2-CER. The customer provides an updated TG4 model with the following update:

- The negative sequence active power limit is added to the model to prevent the total current from exceeding the limit due to the output of negative sequence active current in case of some unbalanced faults

To prove that the updated model mentioned above has no impact on the TG4 report, few tests were repeated. For more details see clause 3.1.3 of this Annex to Certificate

Information appearing in the application form (CPR1FRM5):

- **Date of the application form:** 16/12/2021
- **Applicant:** Sungrow Power Supply Co., Ltd
- **License holder:** Sungrow Power Supply Co., Ltd
- **Factories:**
 1. Sungrow Power Supply Co., Ltd
Address: No.1699 Xiyou Rd.,New & High Technology Industrial Development Zone, Hefei 230088 P.R. China
 2. Sungrow Power Supply Co., Ltd.
Address: No. 608 Changning Avenue, New & High Technology Industrial Development Zone, Hefei 230088 P.R. China.

3. Sungrow Developers (India) Private Limited.

Address: No. 85, Kaniminike village, Kengeri hobli Bangalore South Taluk, 560074 Bangalore, India

• **Product:**

- Type: PV inverter
- Trademark: Sungrow
- Base model: SG50CX
- Input ratings: 200~1000Vdc MPPT (1100Vmax.), 5*26A
- Output ratings: 3/N/PE 400/230V, 50Hz, 72.5A(*)@50KW rated, 83.6A@55KVA max.
- Software Version: LCD_AGATE-S_V11_V01_A , MDSP_AGATE-S_V11_V01_A
- Variant models: SG40CX and SG33CX

Certification service applied:

Certification of PV Inverter according to VDE-AR-N 4110: 2018-11.

0 1 2 3 4 5



1.2 Information about variant models to be included into the scope of the certification process.

Taking as reference the article 2.12.2 of the standard FGW TG8, revision 9, test results can be transferred from test reports to non-tested units taking into account following items:

- a) The design and the control engineering critical to the electrical characteristics including the software used are equivalent in both PGUs from a technical perspective.
- b) The test results for the smallest and the largest power version are available or alternatively the rated power of the power generation unit to be certified is between $1/\sqrt{10}$ times and twice (for Type 2 systems) of the rated power of the power generation unit to be measured.

- **Information of the base model:**

- Brand name base model: SG50CX
- Rated output power base model [kW]: 50 kW
- Firmware version base model: LCD_AGATE-S_V11_V01_A / MDSP_AGATE-S_V11_V01_A.

After the characteristic given for the tested unit (s), test results can be transferred to other non-tested units of complying with the previously mentioned clause a), having output active power comprised between:

- Lower limit: 15.81 kW ($1/\sqrt{10}$ x Base model's Rated output power), and
- Upper limit: 100 kW (2 x Base model's Rated output power)

- **Information of the variant models:**

- Brand name variant model no. 1: SG40CX
- Rated output power variant model no. 1 [kW]: 40 kW
- Firmware version variant model no.1: LCD_AGATE-S_V11_V01_A / MDSP_AGATE-S_V11_V01_A.
- Brand name variant model no. 2: SG33CX
- Rated output power variant model no. 2 [kW]: 33 kW
- Firmware version variant model no.2: LCD_AGATE-S_V11_V01_A / MDSP_AGATE-S_V11_V01_A.

1.3 Summary of the evaluation of the test results

The following documentation is used for the evaluation:

Information of the test report:

- Test report number: 2221 / 0015 – E2
- Issuance date: 12/08/2021.
- Testing laboratory: SGS Tecnos, S.A. (Electrical Testing Laboratory).
- Accreditation number of the laboratory: N° 5/LE011.

Information of the manufacturer declaration:

- Document reference name: Declaration for SG33CX/ SG40CX/ SG50CX TR8 Rev_1
- Issuance date: 29/07/2021.
- Issued by: Sungrow Power Supply Co., Ltd.
- Signed by: John Lee, Standard and Certification Engineer.

0 1 2 3 4 5

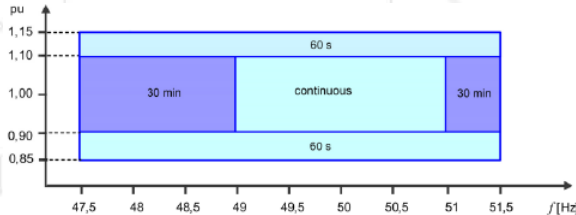

FGW TG8	Title				Result
A.1.2.1 A.2.2.1	Physical part				--
A.1.2.1.1 A.2.2.1.1	Dimensioning of the equipment at the substation				--
	Not applicable to PGU				NA
A.1.2.2 A.2.2.2	Operating range				P
A.1.2.2.1 A.2.2.2.1	Quasi-steady-state operation				--
A.1.2.2.1.1 A.2.2.2.1.1	VDE 4110 Requirement Cl.	VDE 4110 Verification Cl.	Associated documents	Requirement needed	P
	10.2.1.2	11.2.3.1 11.2.4 11.2.5.5	TG3	<input checked="" type="checkbox"/> Manufacturer's declaration <input checked="" type="checkbox"/> Test report	
<p>Evaluated documentation:</p> <ul style="list-style-type: none"> - Manufacturer declaration: "Declaration for SG33CX/ SG40CX/ SG50CX TR8 Rev_1". Dated on July 29th, 2021. Compliance is evidenced by the information declared by the manufacturer in points 3.1.1 and 3.5.2 of this manufacturer declaration. "The entire power generating unit, respectively, including all its associated parts, has been designed for the frequency and voltage ranges of quasi-steady-state operation defined in Figure 4." Figure for VDE-AR-N 4110:2018-11:  <p>"When voltage changes at the inverter AC terminal in the amount of $\Delta U \leq 10\% U_n$ with voltage gradients of $\geq 5\% U_n / \text{min}$ within the voltage band from $90\% U_n$ to $110\% U_n$ occur, inverter has no reduction for active and reactive power and keep connected to the grid."</p> <p>In addition, the clause 3.5.2 of this manufacturer declaration contains details of the capability of the PGU as a voltage-time characteristic curve.</p> <ul style="list-style-type: none"> - Test Report: Test report no. 2221 / 0015 - E2. Dated on August 12th, 2021. Compliance is evidenced by test results provided in points 4.2.1.5, 4.6 and 4.7 of this test report. 					
A.1.2.2.2 A.2.2.2.2	Polar wheel and/or grid oscillation				--
A.1.2.2.2.1 A.2.2.2.2.1	VDE 4110 Requirement Cl.	VDE 4110 Verification Cl.	Associated documents	Requirement needed	NA
	10.2.1.3	11.2.3.2 11.2.3.3	--	<input type="checkbox"/> Manufacturer's declaration	
<p>Remarks: For Type 2 PGU no proof of polar wheel oscillations is required.</p>					

FGW TG8	Title				Result
A.1.2.3 A.2.2.3	System perturbations				P
A.1.2.3.1 A.2.2.3.1	Rapid voltage variations				--
A.1.2.3.1.1 A.2.2.3.1.1	VDE 4110 Requirement Cl.	VDE 4110 Verification Cl.	Associated documents	Requirement needed	P
	5.4.2	11.2.2.1	TG3	<input checked="" type="checkbox"/> Test report	
<u>Evaluated documentation:</u> - Test Report: Test report no. 2221 / 0015 - E2. Dated on August 12th, 2021. Compliance is evidenced by test results provided in the point 4.3.1 of this test report.					
A.1.2.3.2 A.2.2.3.2	Flicker				--
A.1.2.3.2.1 A.2.2.3.2.1	VDE 4110 Requirement Cl.	VDE 4110 Verification Cl.	Associated documents	Requirement needed	P
	5.4.3	11.2.2.2	TG3	<input checked="" type="checkbox"/> Test report	
<u>Evaluated documentation:</u> - Test Report: Test report no. 2221 / 0015 - E2. Dated on August 12th, 2021. Compliance is evidenced by test results provided in the point 4.3.2 of this test report.					
A.1.2.3.3 A.2.2.3.3	Harmonics and Interharmonics				--
A.1.2.3.3.1 A.2.2.3.3.1	VDE 4110 Requirement Cl.	VDE 4110 Verification Cl.	Associated documents	Requirement needed	P
	5.4.4	11.2.2.3	TG3	<input checked="" type="checkbox"/> Test report	
<u>Evaluated documentation:</u> - Test Report: Test report no. 2221 / 0015 - E2. Dated on August 12th, 2021. Compliance is evidenced by test results provided in the points 4.3.3.1 to 4.3.3.4 of this test report.					
A.1.2.3.4 A.2.2.3.4	Commutation notches				--
A.1.2.3.4.1 A.2.2.3.4.1	VDE 4110 Requirement Cl.	VDE 4110 Verification Cl.	Associated documents	Requirement needed	NA
	5.4.5	11.2.2.4	TG3	<input type="checkbox"/> Test report	
<u>Remarks:</u> Evidence only for converters with thyristors which use short-circuit current coming from the grid for commutation of the thyristors. The certified PV inverter doesn't have thyristors which use short-circuit current coming from the grid for commutation of the thyristors.					
A.1.2.3.5 A.2.2.3.5	Asymmetries				--
A.1.2.3.5.1 A.2.2.3.5.1	VDE 4110 Requirement Cl.	VDE 4110 Verification Cl.	Associated documents	Requirement needed	P
	5.4.6	11.2.2.5	TG3	<input checked="" type="checkbox"/> Test report	
<u>Evaluated documentation:</u> - Test Report: Test report no. 2221 / 0015 - E2. Dated on August 12th, 2021. Compliance is evidenced by test results provided in the point 4.3.4 of this test report.					
A.1.2.3.6 A.2.2.3.6	Audio frequency ripple control				--
	Not applicable to PGU				NA
A.1.2.3.7 A.2.2.3.7	Carrier frequency use of the customer grid				--
	Not applicable to PGU				NA

FGW TG8	Title				Result
A.1.2.4 A.2.2.4	Reactive power				P
A.1.2.4.1 A.2.2.4.1	Reactive power provision				--
A.1.2.4.1.1 A.2.2.4.1.1	VDE 4110 Requirement Cl.	VDE 4110 Verification Cl.	Associated documents	Requirement needed	P
	10.2.2.1 to 10.2.2.3	11.2.4	TG3	<input checked="" type="checkbox"/> Manufacturer's declaration <input checked="" type="checkbox"/> Test report	
<p>Evaluated documentation:</p> <ul style="list-style-type: none"> - Manufacturer declaration: "Declaration for SG33CX/ SG40CX/ SG50CX TR8 Rev_1". Dated on July 29th, 2021. Compliance is evidenced by the information declared by the manufacturer in point 3.2.2 of this manufacturer declaration. Among others, main points detailed by the manufacturer are: <i>"In the strategy of reactive power control, follow reactive power is prioritised over the active power."</i> <i>"In the case of lost communication, inverter will response to the latest reactive demand if have not preset reactive power in 'Communication interrupt configuration' in APP iSolarCloud."</i> For further details see the point 4.6 of this document. - Test Report: Test report no. 2221 / 0015 - E2. Dated on August 12th, 2021. Compliance is evidenced by test results provided in points 4.2.1.1, 4.2.1.5, 4.2.2 and 4.2.4 of this test report. 					
A.1.2.4.2 A.2.2.4.2	Procedure for reactive power provision				--
A.1.2.4.2.1 A.2.2.4.2.1	VDE 4110 Requirement Cl.	VDE 4110 Verification Cl.	Associated documents	Requirement needed	P
	10.2.2.4	--	TG3	<input checked="" type="checkbox"/> Manufacturer's declaration <input checked="" type="checkbox"/> Test report	
<p>Evaluated documentation:</p> <ul style="list-style-type: none"> - Manufacturer declaration: "Declaration for SG33CX/ SG40CX/ SG50CX TR8 Rev_1". Dated on July 29th, 2021. Compliance is evidenced by the information declared by the manufacturer in point 3.2.2 of this manufacturer declaration. Among others, main points detailed by the manufacturer are: <i>The following reactive power control mode functions are implemented on the PGU level:</i> <ul style="list-style-type: none"> - <i>Pf - The reactive power can be regulated by the parameter PF (Power Factor).</i> - <i>Qt - The reactive power can be regulated by the parameter 'Reactive Power Ratio' (in %).</i> - <i>Off - The PF is limited to +1.000, and the 'Reactive Power Ratio' is limited to 0.0%.</i> - <i>Q(P) - The reactive ratio or power factor changes with the output power of the inverter.</i> - <i>Q(U) - The reactive power changes with the grid voltage.</i> - Test Report: Test report no. 2221 / 0015 - E2. Dated on August 12th, 2021. 					

FGW TG8	Title				Result
A.1.2.5 A.2.2.5	Active power				P
A.1.2.5.1 A.2.2.5.1	General information and grid safety management				--
A.1.2.5.1.1 A.2.2.5.1.1	VDE 4110 Requirement Cl.	VDE 4110 Verification Cl.	Associated documents	Requirement needed	P
	10.2.4.1 and 10.2.4.2	11.2.7	TG3	<input checked="" type="checkbox"/> Manufacturer's declaration <input checked="" type="checkbox"/> Test report	
<p>Evaluated documentation:</p> <ul style="list-style-type: none"> - Manufacturer declaration: "Declaration for SG33CX/ SG40CX/ SG50CX TR8 Rev_1". Dated on July 29th, 2021. Compliance is evidenced by the information declared by the manufacturer in point 3.3.2 of this manufacturer declaration. For further details of control modes and interfaces see the points 4.2 and 4.4 of this document. - Test Report: Test report no. 2221 / 0015 - E2. Dated on August 12th, 2021. Compliance is evidenced by test results provided in points 4.1.1 and 4.1.2.1 of this test report. 					
A.1.2.5.2 A.2.2.5.2	Active power output as a function of grid frequency				--
A.1.2.5.2.1 A.2.2.5.2.1	VDE 4110 Requirement Cl.	VDE 4110 Verification Cl.	Associated documents	Requirement needed	P
	10.2.4.3	11.2.8	TG3	<input checked="" type="checkbox"/> Manufacturer's declaration <input checked="" type="checkbox"/> Test report	
<p>Evaluated documentation:</p> <ul style="list-style-type: none"> - Manufacturer declaration: "Declaration for SG33CX/ SG40CX/ SG50CX TR8 Rev_1". Dated on July 29th, 2021. Compliance is evidenced by the information declared by the manufacturer in point 3.3.2 of this manufacturer declaration. Among others, main points detailed by the manufacturer are: "When the frequency drops from 49.8Hz to 47.5HzThe inverter will take higher priority for dispatching command set point by grid operator" "P(f)-diagram: When frequency over 50.2Hz and dropping below 49.8Hz, the active power gradients is 100%Pn/s. When frequency returned to rated value (50Hz±0.2Hz) , for the first 10mins, the active power gradients is less than 10%Pn/min, after 10mins quit from abnormal frequency, the active power gradients will back to normal active power gradients: 0.33%Pn/s~0.66%Pn/s." "Dynamic functions: When SG3125HV-20 enter into FTR, the active power reduced to zero to ensure reactive power, after the FTR end according to Figure 4 limit or 5s whichever is the earlier, the active power will recover by max ramp rate within 1s." "In the case of mains frequencies $f > 51.5$ Hz, inverter can operate continuous if not conflict with other grid protection settings." "The ability of RoCoF is more than 4Hz/s if not conflict with other grid protection settings." - Test Report: Test report no. 2221 / 0015 - E2. Dated on August 12th, 2021. Compliance is evidenced by test results provided in the point 4.1.3 of this test report. 					

FGW TG8	Title				Result
A.1.2.6 A.2.2.6	Connection				--
A.1.2.6.1 A.2.2.6.1	Black start capability Not applicable to PGU				-- NA
A.1.2.6.2 A.2.2.6.2	Switching-in conditions				--
A.1.2.6.2.1 A.2.2.6.2.1	VDE 4110 Requirement Cl.	VDE 4110 Verification Cl.	Associated documents	Requirement needed	P
	10.4	11.2.11	TG 3	<input checked="" type="checkbox"/> Manufacturer's declaration <input checked="" type="checkbox"/> Test report	
<p><u>Evaluated documentation:</u></p> <ul style="list-style-type: none"> - Manufacturer declaration: "Declaration for SG33CX/ SG40CX/ SG50CX TR8 Rev_1". Dated on July 29th, 2021. Compliance is evidenced by the information declared by the manufacturer in point 3.4.1 of this manufacturer declaration. Among others, main points detailed by the manufacturer are: "Connection of SG33CX/ SG40CX/ SG50CX is possible at 47.5-50.2Hz (± 0.1 Hz), 90% -110%Un ($\pm 2\%$Un) for VDE-AR-N 4110." "Normal active power gradients: 0.33%Pn/s~0.66%Pn/s (default is 0.45%Pn/s) for stationary connection and reconnection after grid fault trip". "After the inverter trip for protection, when the voltage recovers to at least 95%Un and frequency is between 49.9~50.1Hz, until the stated stabilization time has passed, SG33CX/ SG40CX/ SG50CX has the setting of the delay time of recovery for VDE-AR-N 4110, the setting range is from 0 to 60 mins, default setting is 10 mins." <p>For further details of control modes and interfaces see the point 4.2 of this document.</p> <ul style="list-style-type: none"> - Test Report: Test report no. 2221 / 0015 - E2. Dated on August 12th, 2021. Compliance is evidenced by test results provided in points 4.1.4, 4.5.1 and 4.5.2 of this test report. 					
A.1.2.7 A.2.2.7	FRT				P
A.1.2.7.1 A.2.2.7.1	Loss of static stability				--
A.1.2.7.1.1 A.2.2.7.1.1	VDE 4110 Requirement Cl.	VDE 4110 Verification Cl.	Associated documents	Requirement needed	NA
	10.2.1.3 10.5.2	11.2.12	--	--	
<p><u>Remarks:</u> No evidence necessary.</p>					

FGW TG8	Title				Result
A.1.2.7 A.2.2.7	FRT				P
A.1.2.7.2 A.2.2.7.2	Island and partial grid operation capability				--
A.1.2.7.2.1 A.2.2.7.2.1	VDE 4110 Requirement Cl.	VDE 4110 Verification Cl.	Associated documents	Requirement needed	NA
	10.2.1.4	--	--	<input checked="" type="checkbox"/> Manufacturer's declaration	
<p>Remarks: No requirements for island operation have been defined.</p> <p>Partial grid operation capability does not constitute a minimum requirement. The distribution grid operator may however require partial grid operation capability and the controller stability in individual cases. Only in this case do the following requirements apply. Here only optional characteristics of the PGU are shown, however not a declaration of conformity.</p> <p>Evaluated documentation:</p> <ul style="list-style-type: none"> - Manufacturer declaration: "Declaration for SG33CX/ SG40CX/ SG50CX TR8 Rev_1". Dated on July 29th, 2021. Compliance is evidenced by the information declared by the manufacturer in point 3.5.1 of this manufacturer declaration. "SG33CX/ SG40CX/ SG50CX is not intend to use for Island operation and separate network operation" 					
A.1.2.7.3 A.2.2.7.3	Dynamic grid support				--
A.1.2.7.3.1 A.2.2.7.3.1	VDE 4110 Requirement Cl.	VDE 4110 Verification Cl.	Associated documents	Requirement needed	P
	10.2.1.2 10.2.3	11.2.5	TG 3	<input checked="" type="checkbox"/> Manufacturer's declaration <input checked="" type="checkbox"/> Test report	
<p>Evaluated documentation:</p> <ul style="list-style-type: none"> - Manufacturer declaration: "Declaration for SG33CX/ SG40CX/ SG50CX TR8 Rev_1". Dated on July 29th, 2021. Compliance is evidenced by the information declared by the manufacturer in point 3.5.2 of this manufacturer declaration. - Test Report: Test report no. 2221 / 0015 - E2. Dated on August 12th, 2021. Compliance is evidenced by test results provided in points 4.6 and 4.7 of this test report. The point 4.6 of the test report refers to the attachment I of the report: 2221 / 0015 ATTACHMENT I which includes calculations of short-circuit AC currents. Among others, it is evidenced that the certified product is able to withstand several consecutive voltage dips with the performance of the optional test case 25.3 which indicated in the FGW TG3 (rev. 25) standard. 					

FGW TG8	Title				Result
A.1.2.7 A.2.2.7	FRT				P
A.1.2.7.4 A.2.2.7.4	Contribution to short-circuit current				--
A.1.2.7.4.1 A.2.2.7.4.1	VDE 4110 Requirement Cl.	VDE 4110 Verification Cl.	Associated documents	Requirement needed	P
	10.2.5.2	11.2.9	TG 3	<input checked="" type="checkbox"/> Manufacturer's declaration <input checked="" type="checkbox"/> Test report	
Evaluated documentation: <ul style="list-style-type: none"> - Manufacturer declaration: "Declaration for SG33CX/ SG40CX/ SG50CX TR8 Rev_1". Dated on July 29th, 2021. Compliance is evidenced by the information declared by the manufacturer in point 3.5.3 of this manufacturer declaration. Declared short-circuit currents for certified models are stated below: <ul style="list-style-type: none"> • <u>For SG33CX:</u> <ul style="list-style-type: none"> - Short-circuit surge current i_P (A): 104 A. - Initial symmetrical short-circuit current I_k'' (A): 61 A - Uninterrupted short-circuit current I_k (A): 55.2 A. - Maximal current I_{max} (A): 55.2 A. - R.m.s. value of the source current for three-phase fault, I_{skPF} (First 1-2 cycles of the Fault) = 61 A - R.m.s. value of the source current for two-phase fault, $I(1)sk2PF$ (First 1-2 cycles of the Fault) = 55 A - R.m.s. value of the source current for single-phase fault, $I(1)sk1PF$ (First 1-2 cycles of the Fault)= 49.4 A. • <u>For SG40CX:</u> <ul style="list-style-type: none"> - Short-circuit surge current i_P (A): 125 A. - Initial symmetrical short-circuit current I_k'' (A): 73 A - Uninterrupted short-circuit current I_k (A): 66.9 A. - Maximal current I_{max} (A): 66.9 A. - R.m.s. value of the source current for three-phase fault, I_{skPF} (First 1-2 cycles of the Fault) = 73 A - R.m.s. value of the source current for two-phase fault, $I(1)sk2PF$ (First 1-2 cycles of the Fault) = 66 A - R.m.s. value of the source current for single-phase fault, $I(1)sk1PF$ (First 1-2 cycles of the Fault)= 61.2 A. • <u>For SG50CX:</u> <ul style="list-style-type: none"> - Short-circuit surge current i_P (A): 157 A. - Initial symmetrical short-circuit current I_k'' (A): 92 A - Uninterrupted short-circuit current I_k (A): 83.6 A. - Maximal current I_{max} (A): 83.6 A. - R.m.s. value of the source current for three-phase fault, I_{skPF} (First 1-2 cycles of the Fault) = 92 A - R.m.s. value of the source current for two-phase fault, $I(1)sk2PF$ (First 1-2 cycles of the Fault) = 82 A - R.m.s. value of the source current for single-phase fault, $I(1)sk1PF$ (First 1-2 cycles of the Fault)= 73.4 A. - Test Report: Test report no. 2221 / 0015 - E2. Dated on August 12th, 2021. Compliance is evidenced by test results provided in the point 4.6 of this test report. The point 4.6 of the test report refers to the attachment I of the report: 2221 / 0015 ATTACHMENT I which includes calculations of short-circuit AC currents. 					

FGW TG8	Title				Result
A.1.2.8 A.2.2.8	Protection				P
A.1.2.8.1 A.2.2.8.1	Reserve protection concept				--
	Not applicable to PGU				NA
A.1.2.8.2 A.2.2.8.2	Readability of protection settings				--
A.1.2.8.2.1 A.2.2.8.2.1	VDE 4110 Requirement Cl.	VDE 4110 Verification Cl.	Associated documents	Requirement needed	P
	6.3.3	11.2.10	--	<input checked="" type="checkbox"/> Manufacturer's declaration <input type="checkbox"/> Or component certificate	
<p>Evaluated documentation:</p> <ul style="list-style-type: none"> - Manufacturer declaration: "Declaration for SG33CX/ SG40CX/ SG50CX TR8 Rev_1". Dated on July 29th, 2021. Compliance is evidenced by the information declared by the manufacturer in point 3.6.1 of this manufacturer declaration. <i>"SG33CX/ SG40CX/ SG50CX's protection setting can be easily read by inverter setting APP and the protection setting list is shown as required in the standard of reference."</i> 					
A.1.2.8.3 A.2.2.8.3	Test terminal				--
A.1.2.8.3.1 A.2.2.8.3.1	VDE 4110 Requirement Cl.	VDE 4110 Verification Cl.	Associated documents	Requirement needed	P
	6.3.4.5	11.2.10	--	<input checked="" type="checkbox"/> Manufacturer's declaration	
<p>Evaluated documentation:</p> <ul style="list-style-type: none"> - Manufacturer declaration: "Declaration for SG33CX/ SG40CX/ SG50CX TR8 Rev_1". Dated on July 29th, 2021. Compliance is evidenced by the information declared by the manufacturer in point 3.6.2 of this manufacturer declaration. <i>"SG33CX/ SG40CX/ SG50CX don't provide testing terminal for protection test without disconnect the wires, such test terminal would be supplied at the system level on the LV side of MV transformer."</i> <p>The following deviation is stated in the main certificate, as informative: <i>"The certified product does not provide test terminal. A connecting terminal plate has to be installed separately, if necessary"</i></p>					
A.1.2.8.4 A.2.2.8.4	Operating range				--
A.1.2.8.4.1 A.2.2.8.4.1	VDE 4110 Requirement Cl.	VDE 4110 Verification Cl.	Associated documents	Requirement needed	P
	10.3.4.2.2	11.2.10	TG 3	<input checked="" type="checkbox"/> Manufacturer's declaration <input checked="" type="checkbox"/> Test report	
<p>Evaluated documentation:</p> <ul style="list-style-type: none"> - Manufacturer declaration: "Declaration for SG33CX/ SG40CX/ SG50CX TR8 Rev_1". Dated on July 29th, 2021. Compliance is evidenced by the information declared by the manufacturer in point 3.6.3 of this manufacturer declaration. <i>"There is no additional protection equipment present in SG33CX/ SG40CX/ SG50CX".</i> - Test Report: Test report no. 2221 / 0015 - E2. Dated on August 12th, 2021. Compliance is evidenced by test results provided in the point 4.4 of this test report. 					
A.1.2.8.5 A.2.2.8.5	Voltage protection device and Q(U) protection				--
	Not applicable to PGU				NA

FGW TG8	Title				Result
A.1.2.8 A.2.2.8	Protection				P
A.1.2.8.6 A.2.2.8.6	Accuracy				--
A.1.2.8.6.1 A.2.2.8.6.1	VDE 4110 Requirement Cl.	VDE 4110 Verification Cl.	Associated documents	Requirement needed	P
	10.3.3.2	11.2.10	TG 3	<input checked="" type="checkbox"/> Test report	
Evaluated documentation: - Test Report: Test report no. 2221 / 0015 - E2. Dated on August 12th, 2021. Compliance is evidenced by test results provided in the point 4.4 of this test report. For further details of control modes and interfaces see the point 4.2 of this document.					
A.1.2.8.7 A.2.2.8.7	Independence of the protection functions				--
A.1.2.8.7.1 A.2.2.8.7.1	VDE 4110 Requirement Cl.	VDE 4110 Verification Cl.	Associated documents	Requirement needed	P
	10.3.3.1	11.2.10	--	<input checked="" type="checkbox"/> Manufacturer's declaration	
Evaluated documentation: - Manufacturer declaration: "Declaration for SG33CX/ SG40CX/ SG50CX TR8 Rev_1". Dated on July 29th, 2021. Compliance is evidenced by the information declared by the manufacturer in point 3.6.4 of this manufacturer declaration. <i>"SG33CX/ SG40CX/ SG50CX inverter integrated self-protection function is independent of any control functions".</i> For further details of control modes and interfaces see the point 4.3 of this document.					
A.1.2.8.8 A.2.2.8.8	Protection monitoring				--
	Not applicable to PGU				NA
A.1.2.8.9 A.2.2.8.9	Own and auxiliary power supply				--
A.1.2.8.9.1 A.2.2.8.9.1	VDE 4110 Requirement Cl.	VDE 4110 Verification Cl.	Associated documents	Requirement needed	P
	10.3.3.6	11.2.10	TG 3	<input checked="" type="checkbox"/> Manufacturer's declaration <input type="checkbox"/> Component certificate	
Evaluated documentation: - Manufacturer declaration: "Declaration for SG33CX/ SG40CX/ SG50CX TR8 Rev_1". Dated on July 29th, 2021. Compliance is evidenced by the information declared by the manufacturer in point 3.6.5 of this manufacturer declaration. <i>"SG33CX/ SG40CX/ SG50CX protection system is power supplied by DC side, it's Network-independent auxiliary power supply to the protection equipment for at least 5 seconds. Failure of the auxiliary power supply of the protection equipment or the equipment control, respectively, causes the power generation to be switched off without delay and triggering of the PGU's main switch. The protection equipment provided for meets the requirements for accuracy and setting ranges. (Voltage and current accuracy are ±1%, frequency accuracy is 0.01Hz) Operability of the protection functions shall be provided before the power generating units start feeding in power. Functionality of protection function in the normal frequency operating ranges(Figure 4) is starting from 45Hz up to 55Hz".</i>					
A.1.2.8.9.4 A.2.2.8.9.10	Fault logger				--
	Not applicable to PGU				NA

FGW TG8	Title				Result
A.1.2.8 A.2.2.8	Protection				P
A.1.2.8.10 A.2.2.8.11	Coupling switch				--
A.1.2.8.9.1 A.2.2.8.9.1	VDE 4110 Requirement Cl.	VDE 4110 Verification Cl.	Associated documents	Requirement needed	P
	10.3 10.4.5	--	--	<input checked="" type="checkbox"/> Manufacturer's declaration	
Evaluated documentation:					
<ul style="list-style-type: none"> - Manufacturer declaration: "Declaration for SG33CX/ SG40CX/ SG50CX TR8 Rev_1". Dated on July 29th, 2021. Compliance is evidenced by the information declared by the manufacturer in point 3.6.6 of this manufacturer declaration. 					

0 1 2 3 4 5



1.4 Summary of the evaluation of the validation results

The following documentation is used for the evaluation:

Information of the test report:

- Validation report number: 2221/0015-E1-TG4
- Issuance date: 12/08/2021
- Issued by: SGS Tecnos, S.A. (Electrical Testing Laboratory)
- Simulation model name: VDE_SG50CX_Pf2018
- Version of the simulation model: V1
- MD5 Checksum: 7B9D30E70806F960D35E473F05C68EC6
- Simulation platform: DigSilent PowerFactory
- Simulation platform version: V 20.0.3_A2. The validation report doesn't cover upper version of Digsilent above V 20.0.3_A2.

Revision 3

Report Number: 2221/0015-E1/A-TG4 with date 2022-01-20.

The Dynamic Simulation Model used on this test report is updated with the following modification

- The negative sequence active power limit is added to the model to prevent the total current from exceeding the limit due to the output of negative sequence active current in case of some unbalanced faults

Report Number: 2221/0015-E1/A-TG4 demonstrates that the updated Dynamic Simulation Model (version 3.2) does not show any critical change compared to the previous version used in the original report number 2221/0015-E1-TG4

Software Characteristics used on Test Report 2221/0015-E1/A-TG4

- Validation report number: 2221/0015-E1/A-TG4
- Issuance date: 20-01-2022
- Issued by: SGS Tecnos, S.A. (Electrical Testing Laboratory)
- Simulation model name: VDE_SG33_40_50CX_Pf2018
- Version of the simulation model: V3.2
- MD5 Checksum: F35B4A3146CD2FCEC35D1012BD8646E8
- Simulation platform: DigSilent PowerFactory 2021 SP4B
- Simulation platform version: 21.0.6.0 (11021) / Rev 83448 (*)

(*) Simulation results offered in the validation report were obtained with the Powerfactory Digsilent Version 21.0.6.0. The validation report doesn't cover upper version of Digsilent above Version 21.0.6.0.

Information of the user manual documentation of the dynamic simulation model:

- Document reference name: User Manual and Model Description of DigSILENT PowerFactory Model of SG33CX/SG40CX/SG50CX PV Inverter
- Version: V3.1
- Issuance date: 04/08/2021
- Issued by: Sungrow Power Supply Co., Ltd.

FGW TG8	Title				Result
A.1.2.9 A.2.2.9	Simulation models				P
A.1.2.9.1 A.2.2.9.1	Requirements for simulation models				--
A.1.2.9.1.1 A.2.2.9.1.1	VDE 4110 Requirement Cl.	VDE 4110 Verification Cl.	Associated documents	Requirement needed	P
	10.6	11.2.6	TG4	<input checked="" type="checkbox"/> Validated model <input checked="" type="checkbox"/> Validation report <input checked="" type="checkbox"/> Model documentation	
	Evaluated documentation: - Model Documentation: "User Manual and Model Description of DlgSILENT PowerFactory Model of SG33CX/SG40CX/SG50CX PV Inverter". Rev 3.1 dated on August 04 th , 2021. - Validation Report: Test report no. 2221 / 0015 – E1 – TG4. Dated on August 12 th , 2021.				

0 1 2 3 4 5



Information about the transferability of validation results to derived models:

The validation process according to FGW TG4 (rev. 9) has been completed over the dynamic simulation model for the PV inverter model SG50CX. However, evaluation requirements detailed in the point 5.8.2 of FGW TG4 (Rev. 9), “*Transfer to other PGUs*”, and the chapter 2.12.2 of FGW TG8 (rev. 9) have been considered for the transferability of this validation process to derived models, SG33CX and SG40CX.

As detailed in the validation report no. 2221 / 0015 – E1 – TG4, validation results obtained on the simulation model for SG50CX are essentially valid for derived models, SG40CX and SG33CX. This is ensured since all these referred PV models are based on the same architecture and use the same control strategy. The different model types are achieved by modification of the nominal data in the simulation model.

As a basis for this evaluation, they have also been considered simulations of plausibility tests performed according to FGW TG4 (rev. 9) over the validated simulation model with repetitions of tests at reduced power levels which includes rated power levels of derived models. This includes the verification of following simulation cases over the dynamic simulation model of SG50CX adapted to operate with generation capabilities of derived models SG40CX and SG33CX.

- Verification of Voltage-Dependent PQ diagrams.
- Performance of some aleatory plausibility test cases.

1.5 Evaluation of the ISO 9001 Quality Management System Certificate of manufacturers

Sungrow has 3 factory location where it is produced the certified PV Inverter:

1. Sungrow Power Supply Co., Ltd
Address: No.1699 Xiyou Rd.,New & High Technology Industrial Development Zone, Hefei 230088 P.R. China
2. Sungrow Power Supply Co., Ltd.
Address: No. 608 Changning Avenue, New & High Technology Industrial Development Zone, Hefei 230088 P.R. China.

Evidence: Certificate CN15/21022.00. Issued by SGS (UKAS accredited). Valid until 14th August 2023.



Certificate CN15/21022.00, continued

Sungrow Power Supply Co., Ltd.

ISO 9001:2015

Issue 7.

Detailed scope

Design, development and manufacture of PV (photovoltaic) inverters, wind power converters, data logger, wireless communication module, smart communication box, storage inverters
Manufacture of PV (photovoltaic) inverters, wind power converters, data logger, wireless communication module, smart communication box, storage inverters.
Design, development and manufacture of storage inverters, ESS (energy storage system).
Design and manufacture of electrical drive motor controllers.
Design, development and manufacture of lithium ion storage system battery pack for electric power facilities.

Additional facilities

Sungrow Power Supply Co., Ltd.

Business Registration Address: No. 1699, Xiyou Road, New & High Technology Industrial Development Zone, Hefei City, P.R. China

Business Operation Address: No. 608, Changning Avenue, New & High Technology Industrial Development Zone, He Fei City, Anhui Province, P.R. China

Sungrow-Samsung SDI Energy Storage Power Supply Co., Ltd.

Business Registration Address: No. 788, Mingchuan Road, Boyan Science & Technology Park, New & High Technology Industrial Development Zone, Hefei City, P.R. China

Business Operation Address: No. 788, Mingchuan Road, Boyan Science & Technology Park, New & High Technology Industrial Development Zone, He Fei City, Anhui Province, P.R. China

HeFei E-Power Technology Co., Ltd.

Business Registration Address: Building 2#, No. 88, Wutong Road, New & High Technology Industrial Development Zone, Hefei City, P.R. China

Business Operation Address: Building 2#, No. 88, Wutong Road, New & High Technology Industrial Development Zone, He Fei City, Anhui Province, P.R. China



Page 2 of 3

This document is issued by the Company subject to its General Conditions of Certification (version accessible at www.sgs.com/terms_and_conditions.htm). Attention is drawn to the limitations of liability, indemnification and jurisdictional issues established therein. The authenticity of this document may be verified at <http://www.sgs.com/en/certified-clients-and-products/certified-client-directory>. Any unauthorized alteration, forgery or falsification of the content or appearance of this document is unlawful and offenders may be prosecuted to the fullest extent of the law.

- Sungrow Developers (India) Private Limited.
Address: No. 85, Kaniminike village, Kengeri hobli Bangalore South Taluk, 560074 Bangalore, India
Evidence: Certificate IN18/05814. Issued by SGS (UKAS accredited). Valid until 11th May 2024.



1.7 Compromise letter of the certified product.

Product declaration

We **Sungrow Power Supply Co., Ltd.**

Declare that the product,

- SG50CX

tested by the SGS Tecnos E&E Laboratory Testing, according to the standards,

- VDE-AR-N 4110:2018...
- FGW TG3 (rev.25) according to test report 2221-0015
- FGW TG4 (rev 9) according to test report 2221/0015-TG4
- FGW TG8 (rev 9)

as the same to the model to certify according to above-mentioned standards.

The variant models,

- SG33CX, SG40CX

can be added under scoped of the certification having the same hardware topology and firmware of the tested model.

Date: 28th January.2021

Name: John Lee
Charge: Standard and Certification Engineer

Signature: 



2 OVERVIEW OF RESULTS OF THE FGW TR3 TEST REPORT

Test Report Number: 2221 / 0015 – E2 with date 12-08-2021 according of FGW TR3 rev. 25.

Period of measurement: The necessary testing has been performed between the 28th of December of 2019 and the 24th of June 2021.

Tests in compliance with FGW TR3 rev. 25 have entirely been performed over the PV Inverter model SG50CX. However, test requirements of clauses 4.3.2, 4.3.3 and 4.3.4 of FGW TG3 have been repeated to get corresponding results over variant models SG33CX and SG40CX.

2.1 Nenndaten / Rated data:

For the model Sunny Tripower SG50CX:

Nennscheinleistung S_n	50 kVA	Nennstrom I_n	72.5 A
Nennfrequenz f_n rated frequency f_n	50 Hz	Nennspannung U_n rated Voltage U_n	230 / 400 V

Note: The maximum apparent power of the certified unit SG50CX is 55 kVA.

For the model Sunny Tripower SG40CX:

Nennscheinleistung S_n	40 kVA	Nennstrom I_n	58.0 A
Nennfrequenz f_n rated frequency f_n	50 Hz	Nennspannung U_n rated Voltage U_n	230 / 400 V

Note: The maximum apparent power of the certified unit SG40CX is 44 kVA.

For the model Sunny Tripower SG33CX:

Nennscheinleistung S_n	33 kVA	Nennstrom I_n	47.8 A
Nennfrequenz f_n rated frequency f_n	50 Hz	Nennspannung U_n rated Voltage U_n	230 / 400 V

Note: The maximum apparent power of the certified unit SG40CX is 36.3 kVA.

2.2 Power quality

2.2.1 Wirkleistungsspitzen / Power Peaks

DC Voltage (V)	Wirkleistungsspitzen in kW / Power peaks in kW		Wirkleistungsspitzen in p.u. / Power peaks in p.u.		Anzahl 10-Minuten Datensätze in / Number of 10-minute data set
200	$p_{600} = P_{600}/P_n$	16.525	$p_{60} = P_{60}/P_n$	0.331	1
250	$p_{600} = P_{600}/P_n$	21.132	$p_{60} = P_{60}/P_n$	0.423	1
300	$p_{600} = P_{600}/P_n$	26.181	$p_{60} = P_{60}/P_n$	0.525	1
350	$p_{600} = P_{600}/P_n$	31.919	$p_{60} = P_{60}/P_n$	0.639	1
400	$p_{600} = P_{600}/P_n$	38.211	$p_{60} = P_{60}/P_n$	0.765	1
450	$p_{600} = P_{600}/P_n$	43.724	$p_{60} = P_{60}/P_n$	0.887	1
500	$p_{600} = P_{600}/P_n$	52.021	$p_{60} = P_{60}/P_n$	1.042	1
530	$p_{600} = P_{600}/P_n$	54.379	$p_{60} = P_{60}/P_n$	1.088	1
560	$p_{600} = P_{600}/P_n$	54.429	$p_{60} = P_{60}/P_n$	1.089	1
590	$p_{600} = P_{600}/P_n$	54.522	$p_{60} = P_{60}/P_n$	1.093	1
620	$p_{600} = P_{600}/P_n$	54.830	$p_{60} = P_{60}/P_n$	1.098	1
650	$p_{600} = P_{600}/P_n$	54.829	$p_{60} = P_{60}/P_n$	1.097	1
680	$p_{600} = P_{600}/P_n$	54.699	$p_{60} = P_{60}/P_n$	1.094	1
710	$p_{600} = P_{600}/P_n$	54.672	$p_{60} = P_{60}/P_n$	1.094	1
740	$p_{600} = P_{600}/P_n$	54.531	$p_{60} = P_{60}/P_n$	1.092	1
770	$p_{600} = P_{600}/P_n$	54.479	$p_{60} = P_{60}/P_n$	1.091	1
800	$p_{600} = P_{600}/P_n$	54.532	$p_{60} = P_{60}/P_n$	1.091	1
850	$p_{600} = P_{600}/P_n$	50.264	$p_{60} = P_{60}/P_n$	1.006	1
900	$p_{600} = P_{600}/P_n$	50.570	$p_{60} = P_{60}/P_n$	1.011	1
950	$p_{600} = P_{600}/P_n$	20.057	$p_{60} = P_{60}/P_n$	0.401	1
1000	$p_{600} = P_{600}/P_n$	2.918	$p_{60} = P_{60}/P_n$	0.058	1

Note 1: Note: The MPPT range is 200V to 1000V, while the MPPT range of nominal power is from 500V to 850V (550V to 800V for the maximum power).

As stated in the Manufacturer Declaration for SG33CX/ SG40CX/ SG50CX (Rev 0, dated on January 18th, 2021):

“DC voltage derating curve.”

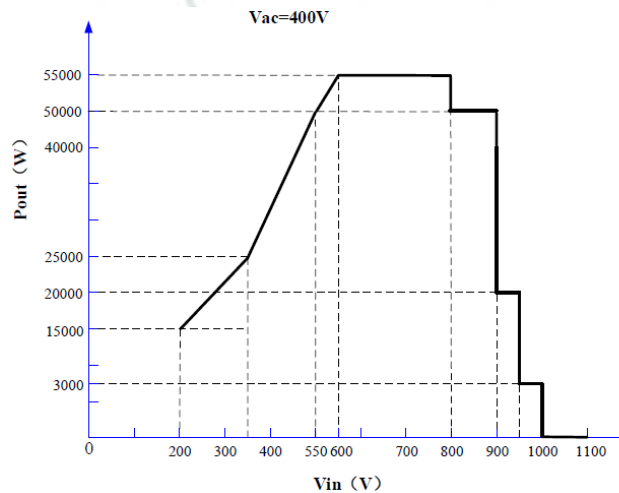

Note 2: Results given are obtained after test results performed on the model SG50CX. STP. These test results for the model SG50CX can be transferred to derived models SG33CX and SG40CX, considering the evaluation offered in the point 1.2 of this document.

2.2.2 Schalthandlungen / Switching Operation

Schalthandlungen / Case of switching operation	Einschalten bei $P_{\text{verfügbar}} < 10\% P_n$ (Einschaltwindgeschw.) / Start-up at $P_{\text{available}} < 10\% P_n$ (cut-in wind speed)				
Max Anz. Schalthandlungen / Max, number of switching operations, N_{10}	20				
Max Anz. Schalthandlungen / Max, number of switching operations, N_{120}	240				
Netzimpedanzwinkel / Grid impedance angle		30°	50°	70°	85°
Flickerformfaktor / Flicker step factor, $k_f (\Psi_k)$	Phase A	0.242	0.217	0.190	0.167
	Phase B	0.240	0.216	0.188	0.164
	Phase C	0.234	0.210	0.185	0.163
Spannungsänderungsfaktor / Voltage change factor, $k_U (\Psi_k)$	Phase A	0.034	0.034	0.034	0.034
	Phase B	0.033	0.033	0.033	0.033
	Phase C	0.031	0.031	0.031	0.031

Schalthandlungen / Case of switching operation	Einschalten bei $P_{\text{verfügbar}} = P_n$ (Nennwindgeschwindigkeit) Start-up at $P_{\text{available}} = P_n$ (rated wind speed)				
Max Anz. Schalthandlungen / Max, number of switching operations, N_{10}	20				
Max Anz. Schalthandlungen / Max, number of switching operations, N_{120}	240				
Netzimpedanzwinkel / Grid impedance angle		30°	50°	70°	85°
Flickerformfaktor / Flicker step factor, $k_f (\Psi_k)$	Phase A	0.873	0.677	0.424	0.228
	Phase B	0.093	0.093	0.093	0.093
	Phase C	0.876	0.683	0.429	0.231
Spannungsänderungsfaktor / Voltage change factor, $k_U (\Psi_k)$	Phase A	0.089	0.089	0.089	0.089
	Phase B	0.877	0.683	0.429	0.232
	Phase C	0.082	0.082	0.082	0.082

Schalthandlungen / Case of switching operation	Seviceabschaltung bei Nennleistung / Cut off at rated power				
Max Anz. Schalthandlungen / Max, number of switching operations, N_{10}	20				
Max Anz. Schalthandlungen / Max, number of switching operations, N_{120}	240				
Netzimpedanzwinkel / Grid impedance angle		30°	50°	70°	85°
Flickerformfaktor / Flicker step factor, $k_f (\Psi_k)$	Phase A	0.739	0.572	0.358	0.190
	Phase B	0.741	0.576	0.362	0.192
	Phase C	0.742	0.577	0.363	0.193
Spannungsänderungsfaktor / Voltage change factor, $k_U (\Psi_k)$	Phase A	0.100	0.100	0.100	0.100
	Phase B	0.096	0.096	0.096	0.096
	Phase C	0.084	0.084	0.084	0.084

Note: Results given are obtained after test results performed on the model SG50CX. STP. These test results for the model SG50CX can be transferred to derived models SG33CX and SG40CX, considering the evaluation offered in the point 1.2 of this document.

2.2.3 Unsymmetrie / Unbalances

Results for the model SG50CX						
P _n (%Sn)	V ₁₊ (V)	V ₁₋ (V)	I ₁₊ (A)	I ₁₋ (A)	U _i (%)	Number of records
110%	230.747	0.663	78.785	0.351	0.446	600
100%	230.317	0.357	72.455	0.041	0.056	600
90%	230.290	0.349	65.852	0.023	0.035	600
80%	230.257	0.335	58.759	0.028	0.048	600
70%	230.230	0.327	51.600	0.033	0.064	600
60%	230.197	0.309	44.412	0.049	0.111	600
50%	230.164	0.294	36.813	0.057	0.154	600
40%	230.134	0.285	29.606	0.060	0.203	600
30%	230.100	0.267	22.338	0.065	0.290	600
20%	230.072	0.260	14.732	0.064	0.436	600
10%	230.042	0.252	7.545	0.067	0.882	600
0%	230.008	0.243	1.524	0.067	4.408	600

Results for the model SG40CX						
P _n (%Sn)	V ₁₊ (V)	V ₁₋ (V)	I ₁₊ (A)	I ₁₋ (A)	U _i (%)	Number of records
110%	230.748	0.457	64.132	0.149	0.232	3000
100%	230.756	0.459	58.019	0.135	0.233	3000
90%	230.752	0.467	52.399	0.125	0.238	3000
80%	230.744	0.465	46.406	0.115	0.247	3000
70%	230.733	0.466	40.709	0.104	0.255	3000
60%	230.725	0.472	34.853	0.095	0.274	3000
50%	230.721	0.468	29.249	0.088	0.299	3000
40%	230.716	0.462	23.166	0.077	0.334	3000
30%	230.687	0.477	17.286	0.071	0.411	3000
20%	230.688	0.459	11.652	0.063	0.542	3000
10%	230.680	0.457	5.679	0.048	0.850	3000
0%	230.670	0.451	1.492	0.041	2.777	3000

Results for the model SG33CX						
P _n (%Sn)	V ₁₊ (V)	V ₁₋ (V)	I ₁₊ (A)	I ₁₋ (A)	U _i (%)	Number of records
110%	230.738	0.461	52.405	0.129	0.247	3000
100%	230.747	0.468	47.733	0.112	0.235	3000
90%	230.737	0.459	43.024	0.110	0.256	3000
80%	230.735	0.462	38.191	0.105	0.275	3000
70%	230.732	0.465	33.426	0.100	0.300	3000
60%	230.725	0.466	28.678	0.091	0.316	3000
50%	230.723	0.458	23.908	0.080	0.336	3000
40%	230.722	0.466	19.126	0.071	0.372	3000
30%	230.684	0.468	14.334	0.068	0.475	3000
20%	230.684	0.459	9.820	0.060	0.607	3000
10%	230.679	0.454	5.076	0.044	0.867	3000
0%	230.670	0.455	1.516	0.045	2.984	3000

Note: According to VDE-AR-N 4110: 2018-11, from the 10%P_n, the generating unit shall not exceed a maximum limit defined at 1.5%, for VDE-AR-N 4110: 2018-11.

2.2.4 Flicker

Results for the model SG50CX				
Phase A				
Netzimpedanzwinkel / Network impedance phase angle, Ψ_k	30°	50°	70°	85°
P (%Pn)	Flickerkoeffizient / Flicker coefficient, C (Ψ_k , Pa)			
5	1.197	1.155	1.117	1.095
10	1.198	1.158	1.124	1.102
20	1.232	1.261	1.293	1.294
30	1.312	1.313	1.308	1.285
40	1.392	1.347	1.288	1.236
50	1.438	1.405	1.350	1.293
60	1.489	1.471	1.442	1.394
70	1.582	1.559	1.521	1.458
80	1.592	1.570	1.534	1.479
90	1.668	1.647	1.635	1.584
95	1.742	1.767	1.789	1.743
100	1.764	1.765	1.763	1.711
110	1.598	1.421	1.181	1.003
Maximum	1.764	1.767	1.789	1.743

Results for the model SG50CX				
Phase B				
Netzimpedanzwinkel / Network impedance phase angle, Ψ_k	30°	50°	70°	85°
P (%Pn)	Flickerkoeffizient / Flicker coefficient, C (Ψ_k , Pa)			
5	1.205	1.129	1.062	1.036
10	1.183	1.126	1.066	1.031
20	1.268	1.248	1.222	1.196
30	1.356	1.289	1.210	1.154
40	1.392	1.293	1.190	1.123
50	1.458	1.359	1.254	1.184
60	1.532	1.434	1.322	1.239
70	1.574	1.461	1.337	1.247
80	1.663	1.586	1.486	1.394
90	1.704	1.631	1.559	1.486
95	1.734	1.643	1.537	1.444
100	1.785	1.680	1.565	1.467
110	1.593	1.418	1.182	1.007
Maximum	1.785	1.680	1.565	1.486

Results for the model SG50CX				
Phase C				
Netzimpedanzwinkel / Network impedance phase angle, Ψ_k	30°	50°	70°	85°
P (%Pn)	Flickerkoeffizient / Flicker coefficient, C (Ψ_k , Pa)			
5	1.200	1.148	1.098	1.072
10	1.193	1.161	1.120	1.091
20	1.296	1.276	1.240	1.200
30	1.372	1.320	1.250	1.193
40	1.433	1.352	1.253	1.178
50	1.454	1.389	1.295	1.217
60	1.580	1.528	1.427	1.327
70	1.612	1.541	1.434	1.331
80	1.655	1.615	1.538	1.448
90	1.705	1.661	1.595	1.513
95	1.795	1.768	1.697	1.587
100	1.807	1.756	1.675	1.577
110	1.590	1.417	1.183	1.010
Maximum	1.807	1.768	1.697	1.587

0 1 2 3 4 5

CEBEC

Results for the model SG40CX				
Phase A				
Netzimpedanzwinkel / Network impedance phase angle, Ψ_k	30°	50°	70°	85°
P (%Pn)	Flickerkoeffizient / Flicker coefficient, C (Ψ_k , Pa)			
0	0.258	0.253	0.257	0.259
10	0.262	0.254	0.255	0.256
20	0.257	0.257	0.265	0.268
30	0.454	0.380	0.328	0.299
40	0.261	0.295	0.322	0.331
50	0.296	0.318	0.352	0.362
60	0.309	0.358	0.404	0.418
70	0.319	0.384	0.439	0.456
80	0.376	0.440	0.504	0.526
90	0.358	0.460	0.537	0.562
100	0.371	0.488	0.569	0.592
110	0.414	0.521	0.603	0.627
Maximum	0.454	0.521	0.603	0.627

Results for the model SG40CX				
Phase B				
Netzimpedanzwinkel / Network impedance phase angle, Ψ_k	30°	50°	70°	85°
P (%Pn)	Flickerkoeffizient / Flicker coefficient, C (Ψ_k , Pa)			
0	0.259	0.245	0.243	0.243
10	0.260	0.253	0.250	0.250
20	0.245	0.259	0.272	0.276
30	0.448	0.378	0.354	0.295
40	0.265	0.299	0.326	0.335
50	0.303	0.336	0.367	0.376
60	0.322	0.378	0.431	0.447
70	0.325	0.385	0.440	0.456
80	0.381	0.445	0.501	0.520
90	0.375	0.474	0.549	0.570
100	0.400	0.541	0.634	0.660
110	0.440	0.545	0.638	0.664
Maximum	0.448	0.545	0.638	0.664

Results for the model SG40CX				
Phase C				
Netzimpedanzwinkel / Network impedance phase angle, Ψ_k	30°	50°	70°	85°
P (%Pn)	Flickerkoeffizient / Flicker coefficient, C (Ψ_k , Pa)			
0	0.265	0.261	0.268	0.272
10	0.261	0.257	0.261	0.265
20	0.264	0.274	0.286	0.289
30	0.453	0.382	0.361	0.324
40	0.280	0.319	0.350	0.361
50	0.302	0.346	0.384	0.396
60	0.322	0.378	0.425	0.440
70	0.341	0.413	0.476	0.495
80	0.378	0.449	0.521	0.543
90	0.379	0.487	0.570	0.595
100	0.415	0.567	0.668	0.698
110	0.435	0.602	0.713	0.745
Maximum	0.453	0.602	0.713	0.745

0 1 2 3 4 5



Results for the model SG33CX				
Phase A				
Netzimpedanzwinkel / Network impedance phase angle, Ψ_k	30°	50°	70°	85°
P (%Pn)	Flickerkoeffizient / Flicker coefficient, C (Ψ_k , Pa)			
0	0.412	0.419	0.423	0.423
10	0.259	0.254	0.256	0.257
20	0.243	0.251	0.260	0.263
30	0.248	0.262	0.277	0.282
40	0.253	0.277	0.296	0.301
50	0.277	0.306	0.330	0.338
60	0.272	0.313	0.348	0.359
70	0.294	0.354	0.398	0.411
80	0.305	0.383	0.437	0.453
90	0.310	0.396	0.458	0.477
100	0.338	0.439	0.509	0.530
110	0.353	0.446	0.518	0.537
Maximum	0.412	0.446	0.518	0.537

Results for the model SG33CX				
Phase B				
Netzimpedanzwinkel / Network impedance phase angle, Ψ_k	30°	50°	70°	85°
P (%Pn)	Flickerkoeffizient / Flicker coefficient, C (Ψ_k , Pa)			
0	0.414	0.415	0.417	0.419
10	0.264	0.254	0.245	0.245
20	0.254	0.259	0.264	0.264
30	0.246	0.261	0.274	0.278
40	0.258	0.281	0.300	0.306
50	0.268	0.304	0.332	0.341
60	0.274	0.319	0.354	0.365
70	0.286	0.347	0.392	0.406
80	0.311	0.395	0.453	0.471
90	0.329	0.425	0.493	0.513
100	0.344	0.448	0.519	0.539
110	0.365	0.468	0.546	0.568
Maximum	0.414	0.468	0.546	0.568

Results for the model SG33CX				
Phase C				
Netzimpedanzwinkel / Network impedance phase angle, Ψ_k	30°	50°	70°	85°
P (%Pn)	Flickerkoeffizient / Flicker coefficient, C (Ψ_k , Pa)			
0	0.406	0.410	0.421	0.427
10	0.275	0.272	0.274	0.276
20	0.251	0.261	0.274	0.279
30	0.261	0.276	0.290	0.295
40	0.271	0.293	0.315	0.324
50	0.287	0.318	0.350	0.361
60	0.291	0.347	0.392	0.407
70	0.306	0.376	0.425	0.441
80	0.322	0.400	0.457	0.475
90	0.344	0.448	0.520	0.541
100	0.360	0.473	0.551	0.574
110	0.378	0.501	0.584	0.607
Maximum	0.406	0.501	0.584	0.607

2.2.5 Oberschwingungsmessungen / Harmonics

SG50CX													
P _n (%)	0	10	20	30	40	50	60	70	80	90	100	110	Max (%)
Nr./ Order	I _h (%)	I _h (%)	I _h (%)	I _h (%)	I _h (%)	I _h (%)	I _h (%)	I _h (%)	I _h (%)	I _h (%)	I _h (%)	I _h (%)	
2	0.083	0.103	0.106	0.417	0.443	0.138	0.127	0.136	0.151	0.192	0.207	0.120	0.443
3	0.098	0.135	0.141	0.418	0.419	0.149	0.142	0.148	0.155	0.184	0.185	0.103	0.419
4	0.072	0.117	0.117	0.251	0.258	0.171	0.165	0.168	0.176	0.213	0.216	0.084	0.258
5	1.074	1.942	1.954	1.382	1.224	0.936	0.550	0.322	0.193	0.214	0.211	0.131	1.954
6	0.038	0.052	0.058	0.130	0.138	0.066	0.061	0.076	0.081	0.086	0.090	0.081	0.138
7	1.413	1.019	1.103	1.126	1.102	1.098	0.841	0.647	0.525	0.387	0.304	0.159	1.413
8	0.042	0.050	0.080	0.066	0.076	0.060	0.067	0.060	0.058	0.065	0.066	0.034	0.080
9	0.044	0.037	0.046	0.099	0.113	0.086	0.090	0.074	0.063	0.073	0.073	0.060	0.113
10	0.036	0.022	0.040	0.052	0.060	0.035	0.045	0.045	0.045	0.048	0.050	0.035	0.060
11	0.442	0.522	0.439	0.129	0.337	0.432	0.396	0.344	0.297	0.337	0.327	0.278	0.522
12	0.023	0.030	0.028	0.083	0.047	0.043	0.047	0.052	0.048	0.053	0.049	0.035	0.083
13	0.323	0.227	0.435	0.153	0.143	0.264	0.258	0.259	0.251	0.289	0.287	0.228	0.435
14	0.026	0.026	0.022	0.063	0.050	0.030	0.039	0.032	0.043	0.053	0.050	0.036	0.063
15	0.032	0.042	0.033	0.075	0.064	0.034	0.032	0.036	0.039	0.046	0.053	0.058	0.075
16	0.020	0.014	0.020	0.034	0.047	0.029	0.035	0.034	0.041	0.042	0.037	0.033	0.047
17	0.242	0.177	0.061	0.270	0.095	0.088	0.151	0.171	0.196	0.220	0.223	0.224	0.270
18	0.023	0.012	0.023	0.033	0.044	0.023	0.027	0.029	0.036	0.041	0.038	0.029	0.044
19	0.152	0.037	0.100	0.218	0.133	0.071	0.092	0.120	0.160	0.187	0.193	0.207	0.218
20	0.018	0.018	0.020	0.026	0.033	0.025	0.027	0.031	0.027	0.033	0.036	0.022	0.036
21	0.026	0.021	0.026	0.030	0.032	0.027	0.027	0.029	0.034	0.041	0.040	0.047	0.047
22	0.016	0.016	0.017	0.022	0.038	0.023	0.025	0.029	0.032	0.038	0.035	0.038	0.038
23	0.155	0.095	0.106	0.023	0.128	0.075	0.047	0.080	0.112	0.135	0.154	0.163	0.163
24	0.018	0.016	0.015	0.026	0.021	0.018	0.019	0.020	0.026	0.032	0.035	0.024	0.035
25	0.102	0.017	0.046	0.087	0.088	0.074	0.044	0.057	0.096	0.123	0.138	0.157	0.157
26	0.016	0.011	0.013	0.027	0.024	0.021	0.023	0.023	0.025	0.024	0.025	0.024	0.027
27	0.025	0.013	0.014	0.028	0.025	0.023	0.025	0.025	0.028	0.033	0.035	0.034	0.035
28	0.024	0.010	0.011	0.026	0.018	0.019	0.021	0.023	0.023	0.025	0.026	0.023	0.026
29	0.086	0.041	0.044	0.121	0.020	0.059	0.052	0.040	0.078	0.089	0.116	0.117	0.121
30	0.019	0.008	0.009	0.020	0.014	0.016	0.016	0.018	0.022	0.024	0.025	0.020	0.025
31	0.067	0.015	0.049	0.090	0.043	0.060	0.057	0.035	0.070	0.091	0.114	0.107	0.114
32	0.016	0.008	0.009	0.023	0.018	0.022	0.020	0.023	0.023	0.024	0.022	0.026	0.026
33	0.020	0.010	0.011	0.034	0.028	0.023	0.022	0.022	0.026	0.026	0.030	0.029	0.034
34	0.017	0.007	0.008	0.016	0.022	0.021	0.018	0.022	0.023	0.020	0.021	0.017	0.023
35	0.054	0.019	0.014	0.025	0.068	0.045	0.056	0.021	0.051	0.060	0.087	0.086	0.087
36	0.016	0.006	0.007	0.022	0.028	0.016	0.016	0.016	0.019	0.019	0.019	0.017	0.028
37	0.041	0.015	0.019	0.056	0.064	0.036	0.059	0.022	0.035	0.049	0.079	0.073	0.079
38	0.015	0.006	0.006	0.020	0.025	0.019	0.017	0.018	0.019	0.018	0.019	0.018	0.025
39	0.018	0.007	0.008	0.024	0.028	0.019	0.019	0.020	0.022	0.021	0.023	0.025	0.028
40	0.016	0.005	0.006	0.020	0.022	0.020	0.017	0.018	0.022	0.019	0.017	0.017	0.022
41	0.044	0.014	0.018	0.064	0.029	0.033	0.059	0.025	0.025	0.042	0.065	0.068	0.068
42	0.016	0.004	0.004	0.019	0.015	0.014	0.014	0.015	0.019	0.018	0.018	0.017	0.019
43	0.033	0.010	0.011	0.047	0.017	0.041	0.051	0.028	0.018	0.027	0.053	0.058	0.058
44	0.016	0.004	0.004	0.020	0.017	0.017	0.018	0.017	0.018	0.017	0.018	0.016	0.020
45	0.018	0.005	0.005	0.027	0.018	0.016	0.019	0.020	0.022	0.020	0.020	0.023	0.027
46	0.014	0.004	0.003	0.013	0.012	0.013	0.016	0.015	0.019	0.018	0.015	0.013	0.019
47	0.039	0.010	0.010	0.021	0.030	0.047	0.042	0.028	0.022	0.029	0.048	0.053	0.053
48	0.014	0.003	0.003	0.017	0.015	0.013	0.013	0.012	0.016	0.016	0.016	0.015	0.017
49	0.038	0.009	0.008	0.036	0.040	0.054	0.041	0.035	0.022	0.028	0.046	0.057	0.057
50	0.027	0.003	0.003	0.031	0.032	0.034	0.034	0.034	0.035	0.034	0.034	0.013	0.035
TDC (%)	1.904	2.288	2.348	1.963	1.849	1.575	1.178	0.933	0.826	0.834	0.823	0.657	2.348

SG40CX													
P _n (%)	0	10	20	30	40	50	60	70	80	90	100	110	Max (%)
Nr./ Order	I _h (%)	I _h (%)	I _h (%)	I _h (%)	I _h (%)	I _h (%)	I _h (%)	I _h (%)	I _h (%)	I _h (%)	I _h (%)	I _h (%)	I _h (%)
2	0.073	0.063	0.059	0.093	0.093	0.094	0.107	0.119	0.112	0.121	0.119	0.137	0.137
3	0.039	0.049	0.156	0.051	0.048	0.044	0.052	0.057	0.054	0.059	0.067	0.096	0.156
4	0.044	0.035	0.043	0.054	0.050	0.064	0.068	0.067	0.067	0.058	0.053	0.062	0.068
5	2.546	2.363	3.099	2.599	2.242	1.674	1.119	0.706	0.414	0.208	0.105	0.356	3.099
6	0.078	0.077	0.088	0.095	0.094	0.098	0.099	0.098	0.095	0.097	0.099	0.088	0.099
7	1.738	1.616	1.211	1.586	1.822	1.624	1.315	1.033	0.827	0.677	0.573	0.362	1.822
8	0.024	0.030	0.024	0.047	0.033	0.045	0.051	0.052	0.053	0.048	0.047	0.043	0.053
9	0.040	0.044	0.026	0.041	0.049	0.055	0.049	0.047	0.053	0.051	0.055	0.056	0.056
10	0.016	0.010	0.024	0.017	0.029	0.030	0.025	0.021	0.021	0.027	0.033	0.042	0.042
11	0.760	0.684	0.739	0.419	0.255	0.570	0.527	0.457	0.418	0.369	0.310	0.337	0.760
12	0.013	0.022	0.035	0.013	0.016	0.017	0.021	0.014	0.011	0.013	0.018	0.024	0.035
13	0.552	0.463	0.123	0.551	0.089	0.229	0.331	0.273	0.282	0.297	0.273	0.309	0.552
14	0.015	0.014	0.010	0.017	0.017	0.027	0.030	0.034	0.022	0.016	0.017	0.022	0.034
15	0.022	0.024	0.026	0.033	0.033	0.017	0.018	0.021	0.022	0.026	0.027	0.027	0.033
16	0.018	0.021	0.015	0.017	0.023	0.020	0.022	0.021	0.017	0.014	0.016	0.021	0.023
17	0.256	0.213	0.275	0.194	0.304	0.079	0.079	0.170	0.164	0.195	0.215	0.259	0.304
18	0.018	0.017	0.012	0.013	0.023	0.015	0.015	0.022	0.019	0.014	0.015	0.018	0.023
19	0.176	0.152	0.232	0.040	0.225	0.152	0.067	0.071	0.132	0.142	0.164	0.215	0.232
20	0.014	0.016	0.016	0.014	0.018	0.016	0.018	0.011	0.020	0.022	0.018	0.017	0.022
21	0.013	0.015	0.016	0.026	0.019	0.015	0.016	0.013	0.012	0.014	0.015	0.016	0.026
22	0.010	0.012	0.012	0.012	0.010	0.016	0.016	0.012	0.013	0.019	0.021	0.016	0.021
23	0.086	0.074	0.076	0.172	0.087	0.101	0.109	0.039	0.044	0.108	0.109	0.142	0.172
24	0.011	0.009	0.012	0.011	0.010	0.015	0.012	0.011	0.009	0.014	0.016	0.014	0.016
25	0.086	0.064	0.189	0.137	0.078	0.072	0.119	0.061	0.029	0.101	0.106	0.126	0.189
26	0.010	0.010	0.009	0.010	0.011	0.010	0.011	0.011	0.012	0.010	0.015	0.017	0.017
27	0.014	0.014	0.017	0.019	0.018	0.017	0.013	0.012	0.012	0.013	0.017	0.015	0.019
28	0.008	0.009	0.009	0.011	0.010	0.011	0.010	0.011	0.010	0.009	0.017	0.017	0.017
29	0.061	0.045	0.020	0.036	0.104	0.056	0.066	0.082	0.018	0.065	0.094	0.103	0.104
30	0.008	0.010	0.014	0.009	0.011	0.014	0.011	0.010	0.012	0.012	0.011	0.014	0.014
31	0.063	0.053	0.145	0.112	0.087	0.068	0.055	0.106	0.056	0.063	0.098	0.115	0.145
32	0.010	0.009	0.012	0.008	0.010	0.010	0.009	0.009	0.009	0.010	0.010	0.010	0.012
33	0.013	0.014	0.017	0.024	0.018	0.016	0.014	0.017	0.014	0.014	0.014	0.014	0.024
34	0.009	0.010	0.009	0.009	0.010	0.008	0.009	0.008	0.009	0.010	0.009	0.008	0.010
35	0.046	0.045	0.050	0.072	0.027	0.083	0.014	0.087	0.066	0.034	0.064	0.086	0.087
36	0.009	0.011	0.011	0.010	0.012	0.008	0.012	0.009	0.010	0.008	0.009	0.008	0.012
37	0.036	0.035	0.091	0.026	0.043	0.074	0.025	0.074	0.052	0.027	0.045	0.070	0.091
38	0.009	0.012	0.011	0.010	0.010	0.011	0.011	0.010	0.010	0.009	0.010	0.009	0.012
39	0.013	0.013	0.017	0.019	0.018	0.016	0.018	0.016	0.016	0.012	0.014	0.013	0.019
40	0.009	0.010	0.010	0.009	0.010	0.009	0.011	0.009	0.010	0.008	0.009	0.009	0.011
41	0.036	0.030	0.065	0.072	0.076	0.045	0.048	0.068	0.053	0.025	0.039	0.057	0.076
42	0.010	0.010	0.011	0.010	0.009	0.010	0.011	0.010	0.009	0.010	0.010	0.010	0.011
43	0.030	0.031	0.036	0.073	0.059	0.021	0.070	0.062	0.058	0.022	0.032	0.045	0.073
44	0.009	0.011	0.011	0.009	0.009	0.010	0.010	0.011	0.010	0.009	0.010	0.009	0.011
45	0.016	0.019	0.018	0.022	0.022	0.023	0.023	0.027	0.022	0.023	0.022	0.021	0.027
46	0.008	0.009	0.010	0.008	0.008	0.009	0.009	0.008	0.009	0.008	0.008	0.008	0.010
47	0.025	0.023	0.049	0.020	0.012	0.031	0.072	0.049	0.055	0.022	0.030	0.043	0.072
48	0.008	0.009	0.009	0.008	0.009	0.010	0.009	0.009	0.008	0.009	0.009	0.008	0.010
49	0.021	0.019	0.027	0.035	0.029	0.044	0.071	0.046	0.053	0.025	0.031	0.047	0.071
50	0.007	0.008	0.006	0.007	0.007	0.008	0.007	0.009	0.009	0.009	0.008	0.006	0.009
TDC (%)	3.245	2.998	3.448	3.146	2.939	2.434	1.863	1.405	1.104	0.927	0.823	0.845	3.448

SG33CX													
P _n (%)	0	10	20	30	40	50	60	70	80	90	100	110	Max (%)
Nr./ Order	I _h (%)	I _h (%)	I _h (%)	I _h (%)	I _h (%)	I _h (%)	I _h (%)	I _h (%)	I _h (%)	I _h (%)	I _h (%)	I _h (%)	I _h (%)
2	0.088	0.080	0.047	0.113	0.096	0.110	0.120	0.123	0.140	0.145	0.145	0.142	0.145
3	0.046	0.057	0.200	0.102	0.078	0.066	0.055	0.054	0.048	0.057	0.060	0.093	0.200
4	0.054	0.049	0.049	0.072	0.055	0.060	0.077	0.081	0.084	0.084	0.078	0.083	0.084
5	3.085	2.882	3.586	3.240	3.032	2.613	2.081	1.508	1.053	0.680	0.442	0.228	3.586
6	0.094	0.098	0.078	0.115	0.109	0.114	0.119	0.119	0.119	0.117	0.117	0.109	0.119
7	2.107	1.992	1.685	1.393	2.100	2.206	1.997	1.688	1.392	1.147	0.955	0.746	2.206
8	0.028	0.036	0.028	0.057	0.048	0.045	0.050	0.056	0.062	0.064	0.060	0.060	0.064
9	0.048	0.046	0.098	0.048	0.051	0.063	0.064	0.065	0.066	0.064	0.061	0.071	0.098
10	0.019	0.011	0.020	0.018	0.028	0.037	0.039	0.031	0.030	0.029	0.030	0.035	0.039
11	0.921	0.840	0.831	0.942	0.251	0.365	0.676	0.685	0.574	0.533	0.496	0.523	0.942
12	0.016	0.021	0.038	0.021	0.012	0.020	0.021	0.030	0.021	0.021	0.016	0.023	0.038
13	0.669	0.586	0.214	0.632	0.517	0.045	0.263	0.389	0.355	0.332	0.346	0.407	0.669
14	0.018	0.018	0.029	0.014	0.016	0.023	0.027	0.036	0.041	0.033	0.025	0.022	0.041
15	0.026	0.025	0.037	0.032	0.049	0.035	0.022	0.019	0.024	0.027	0.028	0.028	0.049
16	0.022	0.025	0.018	0.026	0.025	0.027	0.021	0.022	0.030	0.025	0.020	0.020	0.030
17	0.309	0.259	0.393	0.112	0.343	0.347	0.121	0.089	0.149	0.219	0.204	0.244	0.393
18	0.022	0.022	0.017	0.021	0.025	0.028	0.019	0.018	0.021	0.025	0.022	0.020	0.028
19	0.213	0.193	0.127	0.327	0.105	0.265	0.195	0.089	0.044	0.134	0.156	0.170	0.327
20	0.018	0.017	0.018	0.012	0.015	0.024	0.019	0.025	0.016	0.018	0.026	0.028	0.028
21	0.015	0.016	0.023	0.024	0.029	0.024	0.019	0.024	0.017	0.016	0.016	0.018	0.029
22	0.012	0.013	0.012	0.014	0.015	0.014	0.019	0.021	0.018	0.014	0.020	0.019	0.021
23	0.104	0.087	0.149	0.137	0.150	0.104	0.128	0.147	0.077	0.015	0.079	0.118	0.150
24	0.013	0.012	0.016	0.013	0.016	0.013	0.018	0.016	0.010	0.013	0.011	0.016	0.018
25	0.104	0.090	0.070	0.091	0.173	0.078	0.087	0.132	0.108	0.044	0.052	0.095	0.173
26	0.012	0.011	0.016	0.012	0.012	0.014	0.014	0.013	0.014	0.013	0.014	0.011	0.016
27	0.017	0.015	0.021	0.018	0.030	0.020	0.020	0.020	0.014	0.015	0.015	0.015	0.030
28	0.010	0.010	0.015	0.014	0.015	0.011	0.014	0.012	0.012	0.014	0.012	0.009	0.015
29	0.074	0.054	0.107	0.160	0.056	0.112	0.071	0.070	0.098	0.072	0.020	0.047	0.160
30	0.010	0.012	0.013	0.012	0.017	0.010	0.016	0.014	0.010	0.011	0.016	0.013	0.017
31	0.077	0.070	0.031	0.070	0.066	0.107	0.092	0.039	0.102	0.116	0.053	0.044	0.116
32	0.012	0.010	0.013	0.012	0.014	0.011	0.012	0.014	0.011	0.014	0.011	0.010	0.014
33	0.015	0.016	0.020	0.019	0.021	0.025	0.021	0.020	0.019	0.019	0.016	0.016	0.025
34	0.010	0.011	0.013	0.011	0.009	0.013	0.010	0.013	0.010	0.010	0.012	0.010	0.013
35	0.056	0.055	0.072	0.099	0.106	0.025	0.100	0.027	0.067	0.112	0.066	0.029	0.112
36	0.011	0.013	0.017	0.010	0.012	0.016	0.010	0.014	0.010	0.011	0.011	0.009	0.017
37	0.043	0.045	0.060	0.134	0.080	0.033	0.088	0.042	0.048	0.091	0.050	0.019	0.134
38	0.011	0.013	0.014	0.010	0.011	0.011	0.013	0.016	0.013	0.013	0.012	0.011	0.016
39	0.016	0.015	0.020	0.018	0.029	0.022	0.018	0.024	0.023	0.018	0.018	0.014	0.029
40	0.011	0.012	0.016	0.010	0.013	0.012	0.012	0.016	0.011	0.010	0.012	0.009	0.016
41	0.044	0.040	0.068	0.039	0.041	0.082	0.047	0.071	0.032	0.095	0.052	0.025	0.095
42	0.012	0.012	0.014	0.011	0.013	0.010	0.012	0.013	0.013	0.011	0.011	0.011	0.014
43	0.036	0.036	0.040	0.084	0.071	0.075	0.021	0.091	0.037	0.092	0.056	0.031	0.092
44	0.011	0.013	0.015	0.011	0.011	0.011	0.012	0.015	0.012	0.013	0.013	0.011	0.015
45	0.019	0.022	0.033	0.022	0.029	0.029	0.029	0.029	0.033	0.028	0.028	0.027	0.033
46	0.010	0.011	0.011	0.010	0.010	0.010	0.010	0.012	0.010	0.010	0.011	0.010	0.012
47	0.030	0.029	0.052	0.060	0.052	0.025	0.047	0.082	0.047	0.078	0.058	0.031	0.082
48	0.010	0.011	0.012	0.009	0.011	0.012	0.011	0.012	0.012	0.010	0.010	0.010	0.012
49	0.026	0.022	0.054	0.026	0.043	0.031	0.060	0.078	0.051	0.072	0.057	0.032	0.078
50	0.009	0.010	0.010	0.008	0.009	0.009	0.009	0.010	0.009	0.010	0.011	0.010	0.011
TDC (%)	3.933	3.674	4.091	3.741	3.768	3.483	3.003	2.427	1.907	1.540	1.277	1.110	4.091

2.2.6 Zwischenharmonische / Interharmonics

SG50CX													
P _n (%)	0	10	20	30	40	50	60	70	80	90	100	110	Max (%)
Nr./ Order	I _h (%)	I _h (%)	I _h (%)	I _h (%)	I _h (%)	I _h (%)	I _h (%)	I _h (%)	I _h (%)	I _h (%)	I _h (%)	I _h (%)	I _h (%)
75	0.032	0.032	0.048	0.064	0.071	0.058	0.060	0.063	0.065	0.073	0.078	0.077	0.078
125	0.022	0.031	0.040	0.055	0.059	0.044	0.046	0.048	0.049	0.055	0.056	0.066	0.066
175	0.015	0.018	0.025	0.031	0.036	0.030	0.031	0.032	0.033	0.039	0.040	0.039	0.040
225	0.013	0.016	0.021	0.025	0.028	0.025	0.026	0.026	0.027	0.033	0.034	0.035	0.035
275	0.013	0.018	0.020	0.024	0.025	0.023	0.024	0.024	0.025	0.031	0.032	0.031	0.032
325	0.014	0.018	0.020	0.023	0.025	0.023	0.025	0.024	0.025	0.031	0.032	0.035	0.035
375	0.014	0.015	0.019	0.023	0.024	0.023	0.024	0.024	0.024	0.029	0.031	0.032	0.032
425	0.013	0.014	0.018	0.021	0.023	0.022	0.023	0.023	0.024	0.029	0.029	0.033	0.033
475	0.013	0.013	0.018	0.020	0.021	0.022	0.023	0.023	0.024	0.028	0.029	0.031	0.031
525	0.012	0.013	0.018	0.019	0.020	0.022	0.022	0.022	0.023	0.028	0.029	0.053	0.053
575	0.012	0.013	0.017	0.019	0.020	0.021	0.022	0.022	0.022	0.027	0.028	0.028	0.028
625	0.013	0.013	0.017	0.020	0.020	0.021	0.022	0.023	0.023	0.027	0.029	0.057	0.057
675	0.013	0.012	0.016	0.020	0.020	0.021	0.022	0.022	0.022	0.026	0.027	0.031	0.031
725	0.012	0.011	0.016	0.018	0.018	0.020	0.021	0.021	0.022	0.025	0.026	0.033	0.033
775	0.014	0.011	0.015	0.019	0.020	0.021	0.022	0.022	0.023	0.025	0.026	0.027	0.027
825	0.012	0.011	0.015	0.017	0.017	0.019	0.020	0.020	0.021	0.024	0.025	0.032	0.032
875	0.012	0.010	0.014	0.016	0.017	0.019	0.019	0.020	0.020	0.023	0.024	0.024	0.024
925	0.012	0.010	0.014	0.017	0.018	0.019	0.020	0.020	0.021	0.023	0.024	0.028	0.028
975	0.012	0.010	0.014	0.017	0.018	0.019	0.020	0.020	0.020	0.022	0.023	0.025	0.025
1025	0.012	0.009	0.013	0.016	0.017	0.018	0.019	0.020	0.021	0.022	0.022	0.024	0.024
1075	0.013	0.009	0.013	0.017	0.018	0.019	0.020	0.020	0.021	0.022	0.023	0.024	0.024
1125	0.012	0.008	0.012	0.015	0.015	0.017	0.018	0.019	0.020	0.021	0.022	0.028	0.028
1175	0.012	0.008	0.011	0.015	0.015	0.017	0.018	0.018	0.019	0.020	0.021	0.020	0.021
1225	0.012	0.008	0.010	0.015	0.015	0.018	0.018	0.019	0.020	0.021	0.021	0.024	0.024
1275	0.012	0.007	0.010	0.015	0.015	0.017	0.018	0.018	0.019	0.019	0.020	0.022	0.022
1325	0.012	0.007	0.009	0.015	0.014	0.017	0.017	0.018	0.019	0.019	0.020	0.020	0.020
1375	0.012	0.007	0.008	0.015	0.015	0.017	0.018	0.018	0.019	0.019	0.020	0.021	0.021
1425	0.011	0.006	0.008	0.014	0.014	0.016	0.017	0.017	0.018	0.019	0.019	0.027	0.027
1475	0.011	0.006	0.007	0.013	0.014	0.016	0.017	0.017	0.018	0.018	0.019	0.018	0.019
1525	0.012	0.006	0.007	0.014	0.014	0.016	0.017	0.017	0.018	0.019	0.019	0.023	0.023
1575	0.012	0.006	0.006	0.015	0.015	0.016	0.017	0.018	0.018	0.018	0.019	0.018	0.019
1625	0.011	0.005	0.006	0.013	0.014	0.016	0.016	0.017	0.017	0.017	0.018	0.017	0.018
1675	0.012	0.005	0.006	0.015	0.015	0.017	0.017	0.018	0.018	0.018	0.018	0.017	0.018
1725	0.011	0.005	0.006	0.013	0.013	0.015	0.016	0.016	0.017	0.017	0.017	0.021	0.021
1775	0.011	0.005	0.005	0.013	0.013	0.015	0.016	0.016	0.017	0.017	0.017	0.014	0.017
1825	0.011	0.004	0.005	0.013	0.014	0.015	0.016	0.016	0.016	0.017	0.017	0.017	0.017
1875	0.011	0.004	0.005	0.013	0.014	0.015	0.016	0.016	0.016	0.016	0.016	0.015	0.016
1925	0.011	0.004	0.005	0.014	0.014	0.015	0.016	0.017	0.017	0.016	0.016	0.015	0.017
1975	0.012	0.004	0.004	0.014	0.015	0.016	0.016	0.017	0.017	0.016	0.016	0.015	0.017

SG40CX													
P _n (%)	0	10	20	30	40	50	60	70	80	90	100	110	Max (%)
Nr./ Order	I _h (%)	I _h (%)	I _h (%)	I _h (%)	I _h (%)	I _h (%)	I _h (%)	I _h (%)	I _h (%)	I _h (%)	I _h (%)	I _h (%)	I _h (%)
75	0.035	0.035	0.034	0.046	0.042	0.043	0.048	0.049	0.054	0.057	0.060	0.071	0.071
125	0.027	0.028	0.045	0.046	0.050	0.051	0.051	0.052	0.054	0.052	0.056	0.073	0.073
175	0.026	0.027	0.039	0.052	0.048	0.047	0.052	0.052	0.051	0.052	0.054	0.069	0.069
225	0.023	0.023	0.032	0.036	0.034	0.034	0.035	0.035	0.035	0.036	0.038	0.047	0.047
275	0.025	0.025	0.036	0.046	0.047	0.047	0.050	0.048	0.047	0.048	0.051	0.066	0.066
325	0.026	0.028	0.042	0.048	0.047	0.046	0.044	0.044	0.047	0.045	0.048	0.061	0.061
375	0.022	0.023	0.029	0.036	0.035	0.034	0.035	0.034	0.036	0.034	0.036	0.044	0.044
425	0.026	0.027	0.035	0.052	0.045	0.045	0.043	0.042	0.046	0.044	0.047	0.059	0.059
475	0.023	0.025	0.042	0.047	0.044	0.043	0.044	0.043	0.044	0.044	0.048	0.059	0.059
525	0.022	0.022	0.027	0.034	0.033	0.033	0.032	0.033	0.033	0.032	0.033	0.039	0.039
575	0.024	0.025	0.039	0.048	0.042	0.041	0.042	0.043	0.043	0.042	0.045	0.055	0.055
625	0.027	0.027	0.039	0.037	0.041	0.041	0.044	0.041	0.044	0.039	0.044	0.052	0.052
675	0.022	0.023	0.030	0.033	0.032	0.031	0.032	0.032	0.033	0.032	0.033	0.039	0.039
725	0.028	0.027	0.041	0.041	0.042	0.040	0.044	0.041	0.043	0.041	0.045	0.051	0.051
775	0.023	0.024	0.039	0.040	0.039	0.037	0.036	0.037	0.040	0.040	0.044	0.050	0.050
825	0.022	0.023	0.027	0.032	0.030	0.030	0.030	0.028	0.029	0.029	0.030	0.034	0.034
875	0.024	0.026	0.039	0.039	0.039	0.036	0.036	0.036	0.038	0.038	0.042	0.047	0.047
925	0.028	0.028	0.033	0.045	0.041	0.038	0.037	0.036	0.036	0.036	0.039	0.043	0.045
975	0.022	0.023	0.029	0.032	0.030	0.029	0.028	0.028	0.029	0.030	0.031	0.034	0.034
1025	0.029	0.030	0.043	0.040	0.040	0.039	0.036	0.037	0.037	0.036	0.040	0.043	0.043
1075	0.025	0.027	0.037	0.039	0.036	0.032	0.034	0.033	0.035	0.034	0.040	0.043	0.043
1125	0.023	0.024	0.026	0.030	0.029	0.027	0.028	0.026	0.027	0.026	0.029	0.030	0.030
1175	0.025	0.029	0.039	0.038	0.034	0.032	0.033	0.032	0.034	0.033	0.038	0.040	0.040
1225	0.029	0.032	0.032	0.037	0.033	0.035	0.033	0.033	0.033	0.032	0.034	0.035	0.037
1275	0.022	0.025	0.029	0.029	0.027	0.025	0.026	0.026	0.027	0.028	0.029	0.030	0.030
1325	0.030	0.032	0.043	0.043	0.034	0.034	0.034	0.034	0.034	0.033	0.034	0.035	0.043
1375	0.026	0.030	0.035	0.031	0.030	0.030	0.029	0.031	0.031	0.032	0.036	0.037	0.037
1425	0.023	0.024	0.026	0.026	0.025	0.025	0.024	0.024	0.024	0.023	0.024	0.025	0.026
1475	0.025	0.028	0.037	0.030	0.029	0.028	0.028	0.030	0.030	0.029	0.032	0.033	0.037
1525	0.029	0.032	0.034	0.030	0.035	0.029	0.032	0.028	0.031	0.029	0.030	0.029	0.035
1575	0.022	0.025	0.029	0.025	0.025	0.023	0.024	0.024	0.025	0.025	0.026	0.025	0.029
1625	0.029	0.032	0.038	0.027	0.033	0.028	0.032	0.027	0.031	0.029	0.030	0.029	0.038
1675	0.025	0.030	0.034	0.030	0.028	0.026	0.027	0.029	0.028	0.028	0.032	0.032	0.034
1725	0.022	0.024	0.025	0.023	0.023	0.022	0.022	0.023	0.022	0.021	0.022	0.022	0.025
1775	0.024	0.027	0.032	0.027	0.026	0.024	0.024	0.027	0.026	0.025	0.029	0.029	0.032
1825	0.027	0.031	0.034	0.036	0.026	0.030	0.027	0.025	0.030	0.026	0.027	0.025	0.036
1875	0.022	0.024	0.026	0.024	0.022	0.023	0.022	0.023	0.025	0.024	0.024	0.023	0.026
1925	0.026	0.030	0.031	0.031	0.026	0.029	0.027	0.024	0.029	0.026	0.026	0.024	0.031
1975	0.023	0.026	0.030	0.027	0.023	0.023	0.025	0.025	0.024	0.026	0.029	0.028	0.030

SG33CX													
P _n (%)	0	10	20	30	40	50	60	70	80	90	100	110	Max (%)
Nr./ Order	I _h (%)	I _h (%)	I _h (%)	I _h (%)	I _h (%)	I _h (%)	I _h (%)	I _h (%)	I _h (%)	I _h (%)	I _h (%)	I _h (%)	I _h (%)
75	0.044	0.042	0.033	0.045	0.051	0.051	0.053	0.054	0.057	0.059	0.063	0.071	0.071
125	0.033	0.032	0.044	0.057	0.065	0.063	0.060	0.061	0.063	0.065	0.063	0.081	0.081
175	0.031	0.031	0.032	0.057	0.056	0.055	0.060	0.065	0.059	0.064	0.061	0.078	0.078
225	0.028	0.027	0.030	0.042	0.042	0.040	0.042	0.042	0.040	0.044	0.042	0.052	0.052
275	0.031	0.030	0.045	0.054	0.057	0.054	0.059	0.061	0.055	0.060	0.057	0.071	0.071
325	0.032	0.033	0.035	0.056	0.052	0.053	0.055	0.051	0.055	0.055	0.057	0.068	0.068
375	0.027	0.027	0.031	0.042	0.042	0.041	0.041	0.042	0.041	0.043	0.043	0.050	0.050
425	0.031	0.032	0.045	0.057	0.052	0.052	0.054	0.049	0.052	0.053	0.056	0.065	0.065
475	0.028	0.030	0.032	0.061	0.054	0.055	0.051	0.051	0.051	0.054	0.053	0.063	0.063
525	0.026	0.026	0.030	0.041	0.042	0.041	0.039	0.038	0.038	0.041	0.040	0.044	0.044
575	0.029	0.030	0.042	0.060	0.054	0.053	0.049	0.048	0.051	0.054	0.052	0.059	0.060
625	0.032	0.033	0.033	0.054	0.057	0.051	0.051	0.053	0.049	0.052	0.052	0.057	0.057
675	0.026	0.027	0.028	0.045	0.044	0.040	0.037	0.038	0.037	0.040	0.040	0.044	0.045
725	0.033	0.033	0.041	0.060	0.055	0.054	0.050	0.055	0.048	0.053	0.053	0.055	0.060
775	0.028	0.030	0.033	0.055	0.050	0.045	0.046	0.044	0.047	0.047	0.049	0.053	0.055
825	0.027	0.027	0.030	0.039	0.038	0.035	0.037	0.036	0.036	0.036	0.036	0.038	0.039
875	0.030	0.030	0.041	0.052	0.050	0.045	0.046	0.044	0.046	0.045	0.046	0.050	0.052
925	0.034	0.034	0.036	0.042	0.043	0.047	0.046	0.047	0.042	0.046	0.044	0.046	0.047
975	0.027	0.027	0.029	0.036	0.035	0.035	0.036	0.034	0.033	0.036	0.036	0.037	0.037
1025	0.035	0.035	0.039	0.046	0.046	0.045	0.047	0.045	0.043	0.046	0.044	0.046	0.047
1075	0.030	0.032	0.038	0.044	0.044	0.044	0.041	0.043	0.040	0.041	0.042	0.043	0.044
1125	0.027	0.028	0.030	0.034	0.034	0.036	0.032	0.034	0.033	0.033	0.033	0.033	0.036
1175	0.031	0.034	0.038	0.043	0.042	0.042	0.039	0.041	0.038	0.040	0.041	0.041	0.043
1225	0.035	0.038	0.040	0.047	0.048	0.042	0.043	0.037	0.041	0.041	0.039	0.039	0.048
1275	0.027	0.029	0.029	0.034	0.035	0.032	0.031	0.031	0.032	0.033	0.033	0.033	0.035
1325	0.036	0.038	0.037	0.040	0.043	0.044	0.043	0.038	0.042	0.041	0.040	0.039	0.044
1375	0.031	0.035	0.040	0.044	0.041	0.035	0.036	0.035	0.035	0.038	0.038	0.037	0.044
1425	0.028	0.029	0.030	0.033	0.033	0.029	0.031	0.029	0.028	0.030	0.030	0.027	0.033
1475	0.031	0.034	0.035	0.042	0.039	0.033	0.034	0.034	0.033	0.037	0.035	0.034	0.042
1525	0.035	0.038	0.042	0.049	0.039	0.041	0.037	0.039	0.036	0.036	0.037	0.034	0.049
1575	0.027	0.030	0.029	0.034	0.031	0.030	0.029	0.029	0.029	0.030	0.030	0.029	0.034
1625	0.035	0.039	0.034	0.042	0.041	0.038	0.035	0.040	0.035	0.035	0.037	0.034	0.042
1675	0.031	0.034	0.039	0.039	0.033	0.035	0.032	0.032	0.034	0.035	0.033	0.033	0.039
1725	0.026	0.028	0.029	0.028	0.026	0.029	0.028	0.027	0.027	0.028	0.027	0.025	0.029
1775	0.029	0.032	0.033	0.036	0.031	0.033	0.031	0.029	0.032	0.034	0.031	0.029	0.036
1825	0.033	0.036	0.043	0.031	0.036	0.032	0.036	0.038	0.030	0.033	0.035	0.031	0.043
1875	0.027	0.029	0.030	0.028	0.026	0.027	0.028	0.028	0.027	0.029	0.029	0.027	0.030
1925	0.032	0.036	0.032	0.038	0.030	0.033	0.035	0.036	0.028	0.032	0.034	0.031	0.038
1975	0.028	0.031	0.036	0.030	0.033	0.028	0.028	0.032	0.032	0.030	0.030	0.029	0.036

2.2.7 Höhere Frequenzen / Higher Frequencies components

SG50CX													
P _n (%)	0	10	20	30	40	50	60	70	80	90	100	110	Max (%)
F (kHz)	I _h (%)	I _h (%)	I _h (%)	I _h (%)	I _h (%)	I _h (%)	I _h (%)	I _h (%)	I _h (%)	I _h (%)	I _h (%)	I _h (%)	
2.1	0.064	0.020	0.023	0.129	0.048	0.065	0.088	0.054	0.052	0.064	0.094	0.037	0.129
2.3	0.055	0.014	0.013	0.211	0.051	0.062	0.061	0.053	0.053	0.055	0.066	0.071	0.211
2.5	0.058	0.012	0.010	0.150	0.063	0.074	0.068	0.063	0.060	0.061	0.071	0.059	0.150
2.7	0.053	0.012	0.010	0.148	0.053	0.055	0.051	0.064	0.071	0.066	0.071	0.020	0.148
2.9	0.048	0.008	0.006	0.209	0.039	0.039	0.042	0.052	0.060	0.058	0.065	0.018	0.209
3.1	0.088	0.014	0.010	0.239	0.040	0.065	0.064	0.061	0.059	0.057	0.057	0.019	0.239
3.3	0.092	0.011	0.009	0.251	0.060	0.073	0.070	0.069	0.071	0.071	0.072	0.019	0.251
3.5	0.036	0.005	0.005	0.129	0.039	0.042	0.040	0.040	0.039	0.039	0.037	0.019	0.129
3.7	0.041	0.005	0.005	0.140	0.039	0.041	0.037	0.038	0.038	0.038	0.036	0.018	0.140
3.9	0.042	0.004	0.004	0.162	0.048	0.045	0.043	0.046	0.045	0.046	0.042	0.020	0.162
4.1	0.044	0.003	0.003	0.132	0.055	0.051	0.050	0.053	0.051	0.052	0.051	0.021	0.132
4.3	0.036	0.003	0.002	0.145	0.046	0.038	0.037	0.040	0.038	0.039	0.038	0.064	0.145
4.5	0.039	0.003	0.003	0.132	0.045	0.044	0.040	0.043	0.039	0.040	0.039	0.435	0.435
4.7	0.036	0.002	0.002	0.117	0.047	0.039	0.038	0.038	0.037	0.037	0.038	0.106	0.117
4.9	0.036	0.002	0.002	0.128	0.048	0.041	0.040	0.039	0.038	0.039	0.039	0.068	0.128
5.1	0.040	0.002	0.002	0.124	0.051	0.041	0.042	0.040	0.040	0.040	0.041	0.043	0.124
5.3	0.040	0.002	0.002	0.117	0.050	0.042	0.041	0.040	0.041	0.041	0.040	0.000	0.117
5.5	0.043	0.002	0.002	0.124	0.054	0.045	0.044	0.044	0.044	0.044	0.043	0.000	0.124
5.7	0.056	0.002	0.002	0.122	0.069	0.057	0.052	0.054	0.054	0.053	0.052	0.000	0.122
5.9	0.052	0.002	0.002	0.116	0.067	0.056	0.056	0.056	0.054	0.056	0.053	0.000	0.116
6.1	0.058	0.002	0.003	0.127	0.078	0.065	0.061	0.060	0.060	0.063	0.062	0.000	0.127
6.3	0.143	0.005	0.006	0.201	0.176	0.142	0.133	0.132	0.131	0.134	0.133	0.000	0.201
6.5	0.127	0.004	0.005	0.154	0.147	0.129	0.127	0.125	0.125	0.127	0.127	0.000	0.154
6.7	0.085	0.003	0.003	0.151	0.093	0.089	0.090	0.094	0.099	0.103	0.108	0.000	0.151
6.9	0.127	0.004	0.004	0.144	0.121	0.125	0.130	0.129	0.136	0.150	0.155	0.000	0.155
7.1	0.127	0.004	0.004	0.157	0.130	0.126	0.127	0.131	0.137	0.142	0.145	0.000	0.157
7.3	0.151	0.004	0.004	0.157	0.147	0.146	0.147	0.154	0.160	0.165	0.169	0.000	0.169
7.5	0.195	0.005	0.005	0.192	0.184	0.183	0.186	0.188	0.189	0.191	0.195	0.000	0.195
7.7	0.155	0.004	0.004	0.194	0.148	0.148	0.148	0.154	0.157	0.160	0.166	0.000	0.194
7.9	0.198	0.005	0.005	0.190	0.182	0.181	0.183	0.186	0.190	0.200	0.209	0.000	0.209
8.1	0.144	0.003	0.003	0.165	0.135	0.138	0.142	0.146	0.151	0.164	0.174	0.000	0.174
8.3	0.105	0.002	0.002	0.159	0.102	0.102	0.103	0.107	0.108	0.112	0.116	0.000	0.159
8.5	0.096	0.002	0.002	0.126	0.087	0.087	0.089	0.093	0.094	0.095	0.098	0.000	0.126
8.7	0.066	0.001	0.001	0.112	0.065	0.066	0.068	0.071	0.074	0.078	0.080	0.000	0.112
8.9	0.050	0.001	0.001	0.102	0.048	0.049	0.051	0.052	0.053	0.056	0.058	0.000	0.102

SG40CX													
P _n (%)	0	10	20	30	40	50	60	70	80	90	100	110	Max (%)
F (kHz)	I _h (%)	I _h (%)	I _h (%)	I _h (%)	I _h (%)	I _h (%)	I _h (%)	I _h (%)	I _h (%)	I _h (%)	I _h (%)	I _h (%)	
2.1	0.067	0.068	0.094	0.116	0.109	0.071	0.099	0.107	0.094	0.060	0.072	0.089	0.116
2.3	0.053	0.056	0.072	0.057	0.057	0.063	0.090	0.075	0.078	0.060	0.065	0.069	0.090
2.5	0.046	0.048	0.050	0.062	0.060	0.069	0.089	0.077	0.079	0.058	0.058	0.066	0.089
2.7	0.066	0.069	0.071	0.100	0.100	0.101	0.106	0.104	0.103	0.101	0.105	0.101	0.106
2.9	0.064	0.065	0.070	0.076	0.079	0.076	0.070	0.065	0.061	0.068	0.082	0.095	0.095
3.1	0.065	0.065	0.074	0.074	0.072	0.069	0.066	0.065	0.063	0.065	0.070	0.078	0.078
3.3	0.046	0.048	0.056	0.045	0.051	0.047	0.042	0.036	0.035	0.035	0.039	0.042	0.056
3.5	0.035	0.036	0.039	0.042	0.034	0.039	0.037	0.032	0.033	0.029	0.029	0.027	0.042
3.7	0.034	0.039	0.040	0.045	0.034	0.038	0.038	0.033	0.031	0.028	0.029	0.030	0.045
3.9	0.038	0.039	0.039	0.035	0.044	0.035	0.036	0.036	0.040	0.033	0.035	0.033	0.044
4.1	0.039	0.039	0.039	0.039	0.035	0.041	0.037	0.038	0.038	0.034	0.033	0.032	0.041
4.3	0.038	0.040	0.043	0.039	0.037	0.040	0.038	0.038	0.036	0.032	0.032	0.032	0.043
4.5	0.046	0.045	0.046	0.042	0.043	0.040	0.044	0.041	0.040	0.040	0.039	0.037	0.046
4.7	0.038	0.050	0.043	0.036	0.042	0.042	0.036	0.033	0.031	0.031	0.031	0.031	0.050
4.9	0.123	0.112	0.136	0.111	0.111	0.109	0.104	0.100	0.097	0.095	0.093	0.091	0.136
5.1	0.075	0.068	0.076	0.075	0.069	0.067	0.065	0.067	0.065	0.063	0.060	0.059	0.076
5.3	0.042	0.043	0.044	0.040	0.044	0.049	0.047	0.038	0.036	0.036	0.035	0.035	0.049
5.5	0.046	0.045	0.044	0.043	0.044	0.044	0.048	0.045	0.041	0.040	0.040	0.040	0.048
5.7	0.049	0.047	0.045	0.045	0.044	0.043	0.042	0.039	0.037	0.037	0.037	0.037	0.049
5.9	0.036	0.036	0.037	0.036	0.036	0.038	0.035	0.034	0.033	0.031	0.030	0.030	0.038
6.1	0.042	0.040	0.045	0.039	0.039	0.039	0.039	0.038	0.038	0.036	0.035	0.033	0.045
6.3	0.041	0.041	0.040	0.037	0.041	0.039	0.038	0.039	0.038	0.039	0.038	0.035	0.041
6.5	0.042	0.041	0.048	0.039	0.039	0.040	0.039	0.038	0.037	0.036	0.035	0.034	0.048
6.7	0.039	0.038	0.040	0.037	0.037	0.038	0.037	0.036	0.034	0.034	0.033	0.031	0.040
6.9	0.048	0.045	0.055	0.045	0.047	0.045	0.046	0.044	0.044	0.044	0.042	0.040	0.055
7.1	0.041	0.040	0.042	0.040	0.040	0.039	0.038	0.037	0.036	0.035	0.034	0.033	0.042
7.3	0.044	0.042	0.042	0.040	0.040	0.041	0.039	0.038	0.038	0.038	0.037	0.035	0.044
7.5	0.049	0.048	0.047	0.046	0.047	0.046	0.044	0.043	0.043	0.041	0.039	0.037	0.049
7.7	0.046	0.045	0.045	0.043	0.042	0.041	0.040	0.039	0.038	0.038	0.036	0.035	0.046
7.9	0.053	0.051	0.053	0.049	0.047	0.046	0.046	0.045	0.045	0.044	0.044	0.043	0.053
8.1	0.054	0.053	0.051	0.052	0.050	0.049	0.047	0.046	0.046	0.046	0.045	0.045	0.054
8.3	0.060	0.058	0.054	0.055	0.053	0.052	0.050	0.049	0.048	0.047	0.046	0.045	0.060
8.5	0.060	0.059	0.059	0.061	0.057	0.056	0.054	0.053	0.052	0.050	0.050	0.049	0.061
8.7	0.057	0.058	0.056	0.055	0.053	0.052	0.051	0.051	0.050	0.050	0.050	0.050	0.058
8.9	0.060	0.060	0.058	0.058	0.056	0.054	0.053	0.052	0.052	0.052	0.052	0.052	0.060

SG33CX													
P _n (%)	0	10	20	30	40	50	60	70	80	90	100	110	Max (%)
F (kHz)	I _h (%)	I _h (%)	I _h (%)	I _h (%)	I _h (%)	I _h (%)	I _h (%)	I _h (%)	I _h (%)	I _h (%)	I _h (%)	I _h (%)	
2.1	0.081	0.083	0.105	0.110	0.105	0.128	0.079	0.132	0.081	0.147	0.099	0.070	0.147
2.3	0.064	0.067	0.088	0.087	0.087	0.074	0.083	0.107	0.084	0.103	0.089	0.071	0.107
2.5	0.056	0.057	0.079	0.063	0.077	0.072	0.088	0.103	0.087	0.103	0.090	0.068	0.103
2.7	0.080	0.084	0.089	0.103	0.119	0.118	0.121	0.122	0.128	0.128	0.125	0.115	0.128
2.9	0.077	0.079	0.099	0.091	0.094	0.098	0.093	0.088	0.081	0.076	0.075	0.078	0.099
3.1	0.079	0.079	0.090	0.097	0.085	0.087	0.085	0.082	0.077	0.078	0.078	0.078	0.097
3.3	0.056	0.057	0.078	0.056	0.060	0.060	0.059	0.049	0.042	0.046	0.042	0.041	0.078
3.5	0.042	0.043	0.051	0.052	0.043	0.042	0.045	0.043	0.044	0.041	0.039	0.035	0.052
3.7	0.041	0.045	0.057	0.050	0.050	0.041	0.045	0.046	0.045	0.039	0.036	0.033	0.057
3.9	0.046	0.047	0.050	0.064	0.045	0.052	0.045	0.045	0.051	0.043	0.047	0.043	0.064
4.1	0.047	0.047	0.047	0.046	0.048	0.044	0.050	0.046	0.045	0.043	0.046	0.044	0.050
4.3	0.046	0.048	0.053	0.050	0.050	0.045	0.048	0.047	0.046	0.043	0.044	0.042	0.053
4.5	0.056	0.054	0.053	0.047	0.043	0.052	0.047	0.050	0.045	0.047	0.051	0.052	0.056
4.7	0.046	0.058	0.064	0.047	0.048	0.053	0.052	0.044	0.040	0.038	0.037	0.039	0.064
4.9	0.149	0.136	0.137	0.164	0.134	0.135	0.133	0.126	0.123	0.120	0.117	0.116	0.164
5.1	0.090	0.082	0.090	0.098	0.084	0.083	0.082	0.079	0.082	0.080	0.077	0.077	0.098
5.3	0.051	0.052	0.051	0.054	0.048	0.056	0.059	0.059	0.052	0.048	0.045	0.043	0.059
5.5	0.056	0.054	0.055	0.052	0.053	0.054	0.053	0.059	0.057	0.053	0.050	0.049	0.059
5.7	0.060	0.058	0.050	0.057	0.053	0.053	0.053	0.050	0.048	0.047	0.045	0.045	0.060
5.9	0.044	0.044	0.046	0.045	0.041	0.044	0.046	0.045	0.043	0.040	0.040	0.038	0.046
6.1	0.051	0.049	0.048	0.054	0.046	0.046	0.046	0.047	0.047	0.045	0.045	0.044	0.054
6.3	0.050	0.050	0.051	0.047	0.046	0.049	0.048	0.048	0.049	0.046	0.048	0.048	0.051
6.5	0.052	0.049	0.050	0.057	0.046	0.048	0.048	0.048	0.046	0.045	0.045	0.045	0.057
6.7	0.047	0.045	0.047	0.047	0.044	0.045	0.046	0.045	0.043	0.043	0.042	0.042	0.047
6.9	0.058	0.055	0.056	0.065	0.054	0.056	0.055	0.055	0.054	0.054	0.053	0.054	0.065
7.1	0.049	0.048	0.049	0.050	0.047	0.049	0.048	0.046	0.045	0.044	0.043	0.043	0.050
7.3	0.053	0.050	0.051	0.051	0.049	0.049	0.050	0.048	0.048	0.046	0.046	0.046	0.053
7.5	0.060	0.058	0.058	0.057	0.054	0.056	0.056	0.054	0.054	0.051	0.051	0.050	0.060
7.7	0.055	0.054	0.054	0.054	0.052	0.051	0.050	0.049	0.047	0.046	0.046	0.046	0.055
7.9	0.064	0.062	0.062	0.064	0.058	0.057	0.056	0.055	0.055	0.054	0.054	0.054	0.064
8.1	0.066	0.064	0.063	0.064	0.061	0.060	0.059	0.058	0.057	0.056	0.055	0.055	0.066
8.3	0.073	0.071	0.067	0.067	0.064	0.064	0.063	0.061	0.060	0.059	0.057	0.056	0.073
8.5	0.073	0.072	0.073	0.073	0.070	0.070	0.068	0.065	0.065	0.063	0.062	0.061	0.073
8.7	0.070	0.070	0.068	0.068	0.065	0.065	0.063	0.062	0.062	0.061	0.060	0.060	0.070
8.9	0.073	0.073	0.072	0.070	0.069	0.068	0.066	0.064	0.064	0.063	0.063	0.063	0.073

2.3 Grid Control Capability

2.3.1 Wirkleistungseinspeisung in Abhängigkeit der Netzfrequenz / Active power vs frequency

Überfrequenz / overfrequency	Mittlerer Gradient der Wirkleistung zum Zeitpunkt der Frequenzüberhöhung / Mean power gradient at overfrequency	mittl. Gradient / mean gradient 39.8 % P _M /Hz	
	Max. Einschwingzeit / Max. Settling time	0.6 s	
	Gradient der Wirkleistung nach Rückkehr aus Überfrequenz / Power gradient after recovery of over frequency	mittl. Gradient / mean gradient 9.0 %P _n /Hz max. Gradient / max. gradient 9.1 %P _n /Hz	
Unterfrequenz / underfrequency	Mittlerer Gradient der Wirkleistung zum Zeitpunkt der Frequenzunterschreitung / Mean power gradient at underfrequency	mittl. Gradient / mean gradient 40.7 % P _M /Hz	
	Max. Einschwingzeit / Max. Settling time	0.9 s	
	Gradient der Wirkleistung nach Rückkehr aus Unterfrequenz / Power gradient after recovery of under frequency	mittl. Gradient / mean gradient 9.0 %P _n /Hz max. Gradient / max. gradient 9.1 %P _n /Hz	
Die EZE kann mit reduzierter Leistung betrieben werden. / The unit is able to run at reduced power		<input checked="" type="checkbox"/> Ja / Yes	<input type="checkbox"/> Nein / No
Maximale Sollwertabweichung der Wirkleistung Max. deviation of power setting		Überschreitung / Exceeding 1.041 kW	Unterschreitung / Undercut 0.028 kW
Trennung vom Netz bei Wirkleistungssollwertvorgabe von: Disconnection from the grid at external active power setpoints at:		-- % P _n No disconnection is recorded. Operation at 0%P _n is evidenced.	
Einschwingzeit der Leistung für einen Sollwertsprung mit minimalem Gradienten / Response time of the power output after a change in setpoint with minimal gradient	P0 -> P _{min}	Zeit / time : 45.7 s Gradient: 0.34 % P _n / s	
	P _{min} -> P0	Zeit / time : 42.2 s Gradient: 0.34 % P _n / s	
Einschwingzeit der Leistung für einen Sollwertsprung mit maximalem Gradienten / Response time of the power output after a change in setpoint with maximum gradient	P0 -> P _{min}	Zeit / time : 115.3 s Gradient: 0.66 % P _n / s	
	P _{min} -> P0	Zeit / time : 113.6 s Gradient: 0.66 % P _n / s	

Note: Results given are obtained after test results performed on the model SG50CX. STP. These test results for the model SG50CX can be transferred to derived models SG33CX and SG40CX, considering the evaluation offered in the point 1.2 of this document.

As stated in the Manufacturer Declaration for SG33CX / SG40CX / SG50CX (Rev 1, dated on July 29th, 2021):

“Active power output is dependent on the temperature and mppt voltage according to the following curves.”

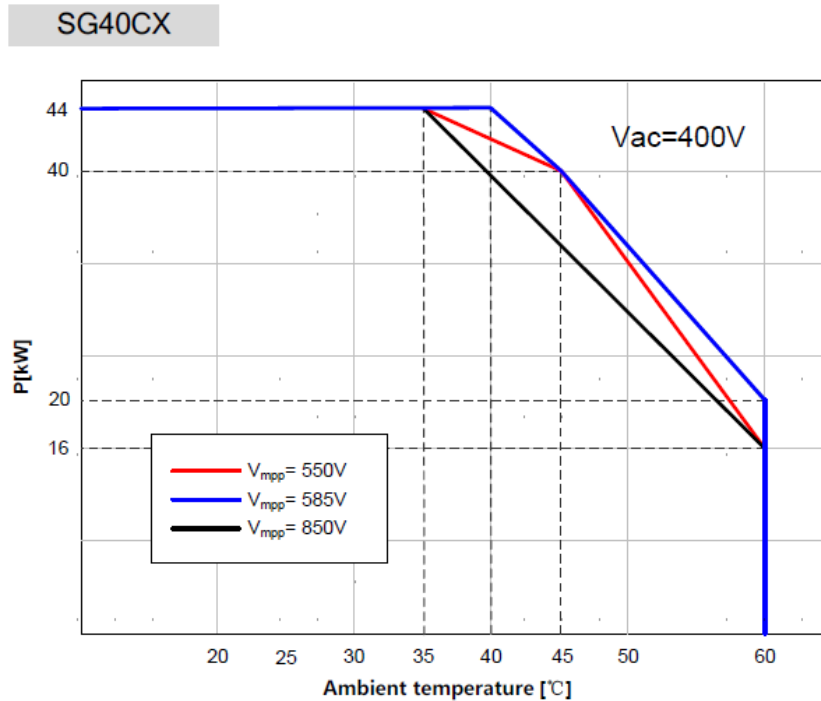
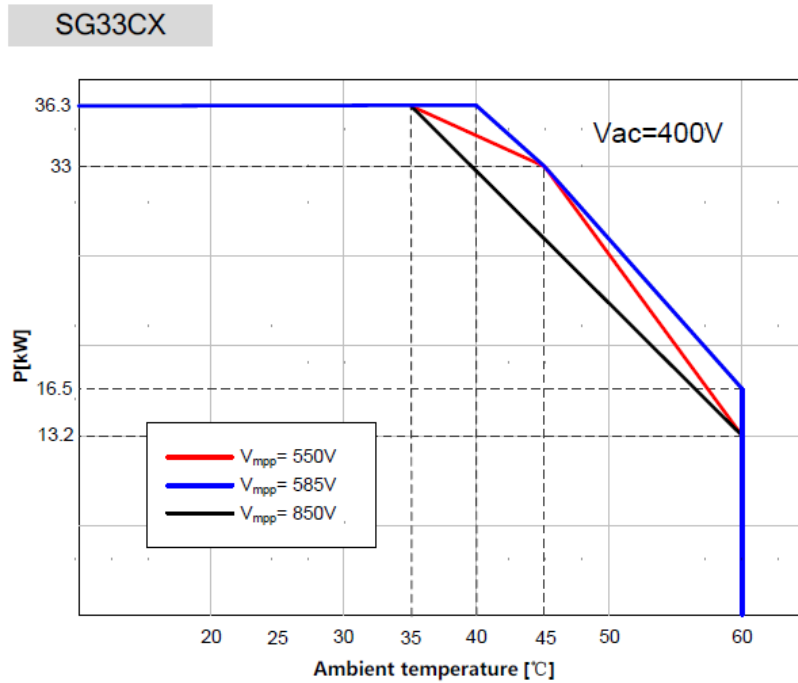

SG50CX

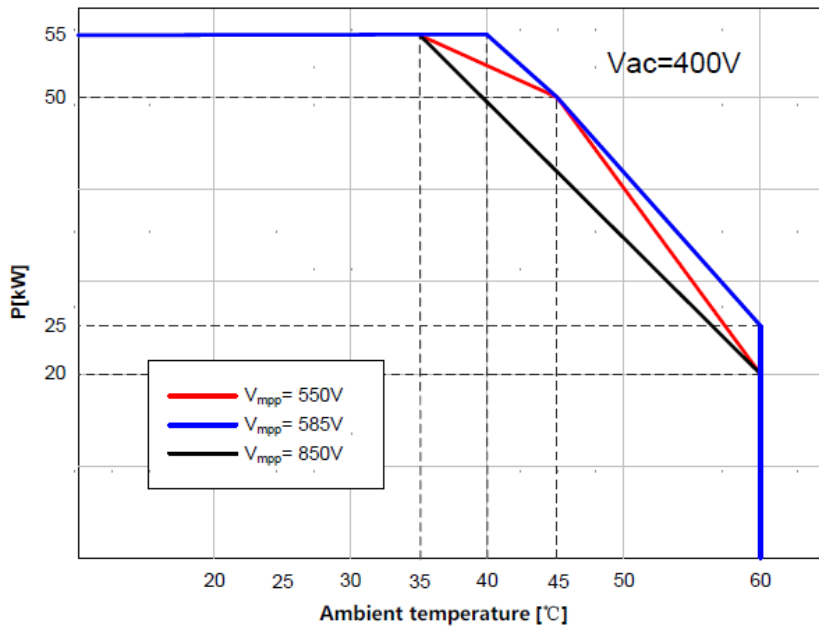

“Active power output is dependent on the altitude according to the following curve.”

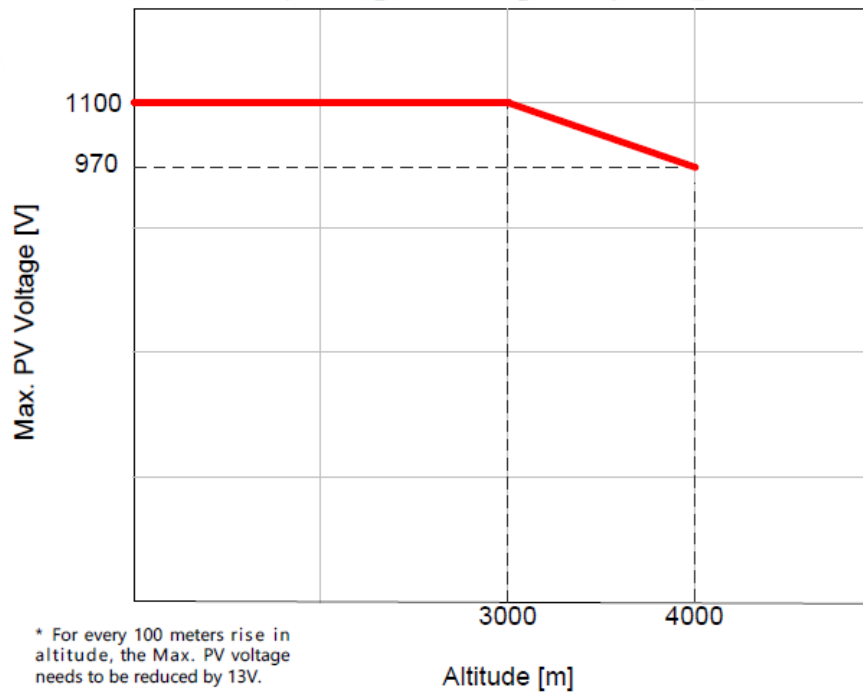

2.3.2 Procedure for reactive power provision

The certified PV inverter fulfils the following P-Q diagram at different voltage levels, as stated in the Manufacturer Declaration for SG33CX / SG40CX / SG50CX (Rev 1, dated on July 29th, 2021):

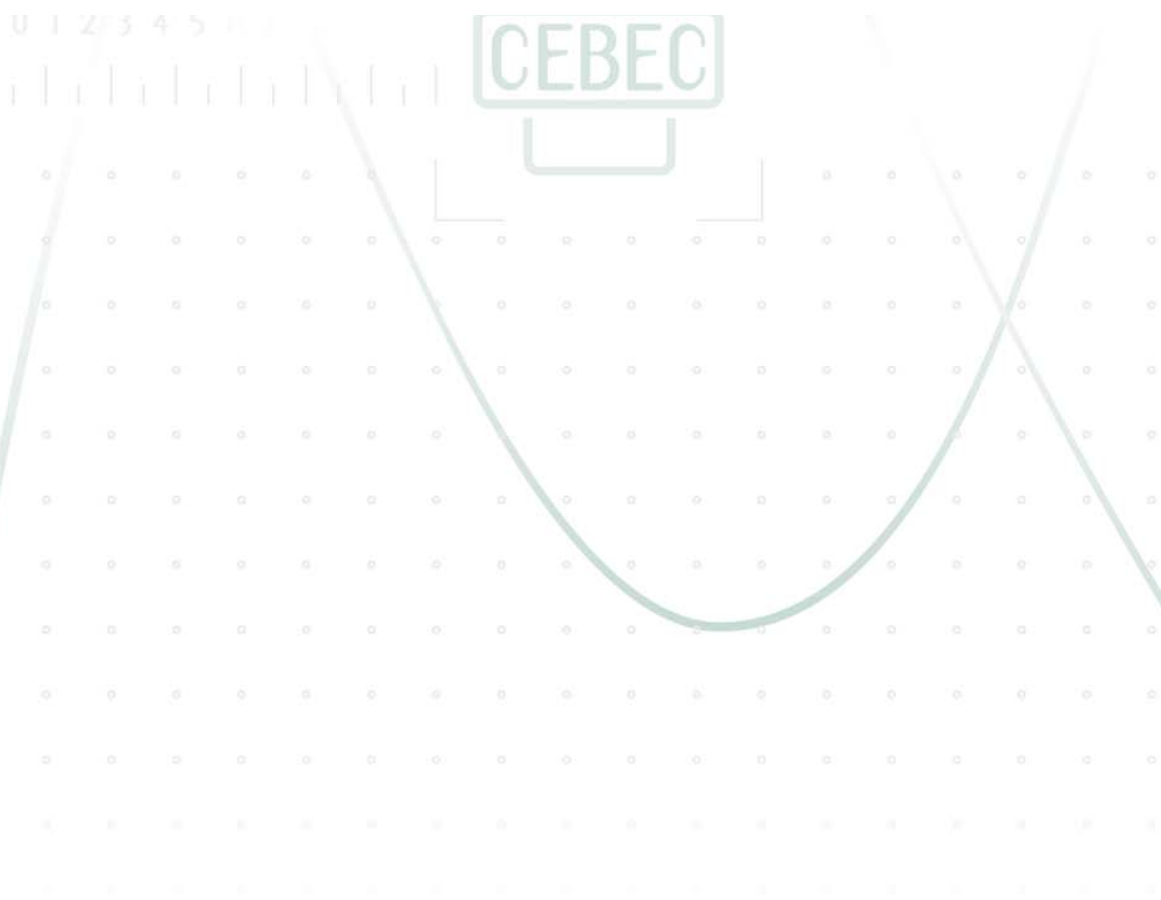
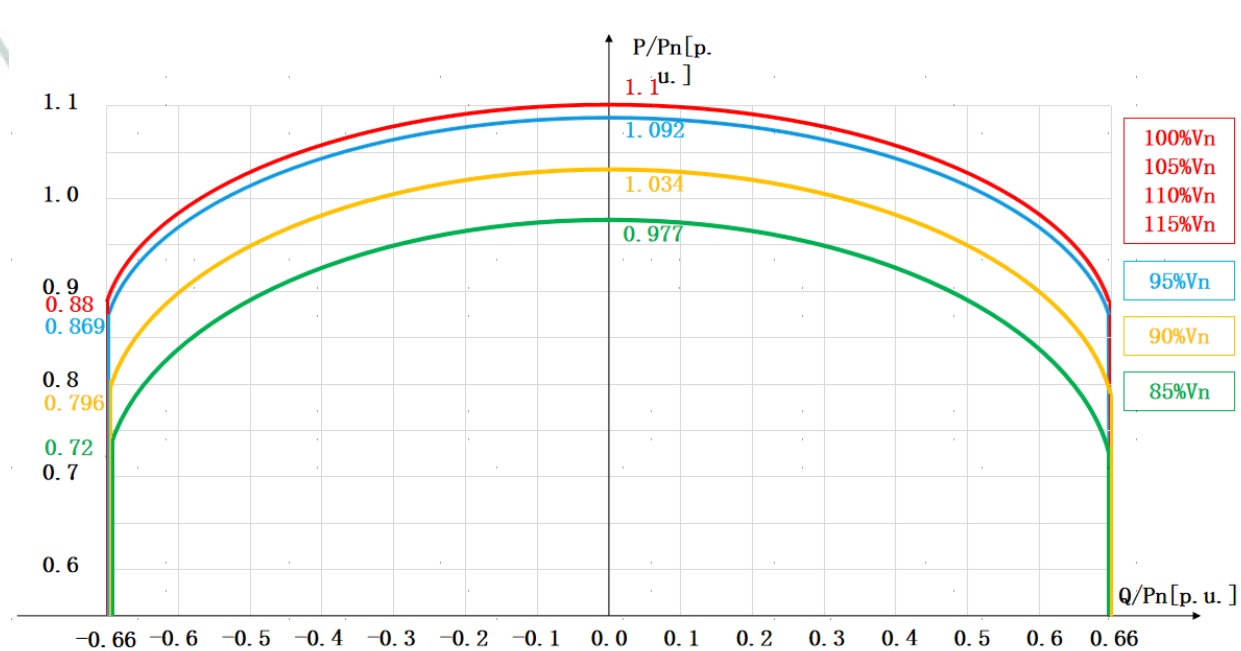

2.3.3 Blindleistungsbereitstellung / Provision of reactive power

Blindleistungsregelung im Normalbetrieb und maximaler Blindleistungstellbereich / Control of reactive power in normal operation and maximum reactive power range	P/Pn	Qind	Q0	Qkap	P/Pn	Qind	Q0	Qkap
	0%	33.571	2.229	-32.997	60%	33.408	1.812	-33.074
	10%	33.514	2.120	-32.986	70%	33.441	1.859	-33.117
	20%	33.458	2.107	-32.978	80%	33.464	1.956	-33.158
	30%	33.422	2.373	-32.986	90%	31.598	2.011	-31.354
	40%	33.395	2.241	-32.985	100%	22.787	1.823	-22.656
	50%	33.390	1.845	-32.990	110%	0.871	0.870	0.869
Q in kVAr.								
Arbeitspunkte des spannungshängigen P-Q Diagramms / Working points of the voltage dependent P-Q diagram	AP / WP		U/Un in %		P/Pn in %		Q in kVAr	
	See measured points and results in the following pages of this annex							
Blindleistungsregelung durch Sollwertvorgabe / Control of reactive power through set point signal	□Verschiebungsfaktor / power factor				☒Blindleistung / reactive power			
	Pbin bei / at Qmax				Q range at 50 %Pn is ± 66 %Pn			
Längste Einsschwingzeit / Longest response time	Parameter				Einschwingzeit / settling time			
	T < 6 s				0.6 s			
	Standardzeit / standard time				--			
	T < 60 s				46.9 s			
Einstellgenauigkeit des Verschiebungsfaktors bzw. Blindleistung / Positioning accuracy of power factor or reactive power	Sollwert / setpoint				Istwert / measured value			
	16.500 kVAr				16.356 kVAr			
	0 kVA				0.072 kVAr			
	-16.500 kVAr				-16.502 kVAr			
Anmerkung / remark	Soweit Q(U) und Q(P)- Regelung wurde, sind diese im Prüfbericht hinterlegt / See Q(U) and Q(P) in test report							

Note: Results given are obtained after test results performed on the model SG50CX. STP. These test results for the model SG50CX can be transferred to derived models SG33CX and SG40CX, considering the evaluation offered in the point 1.2 of this document.

In following charts, they are offered main results after performed tests included in the FGW TG3 test report.

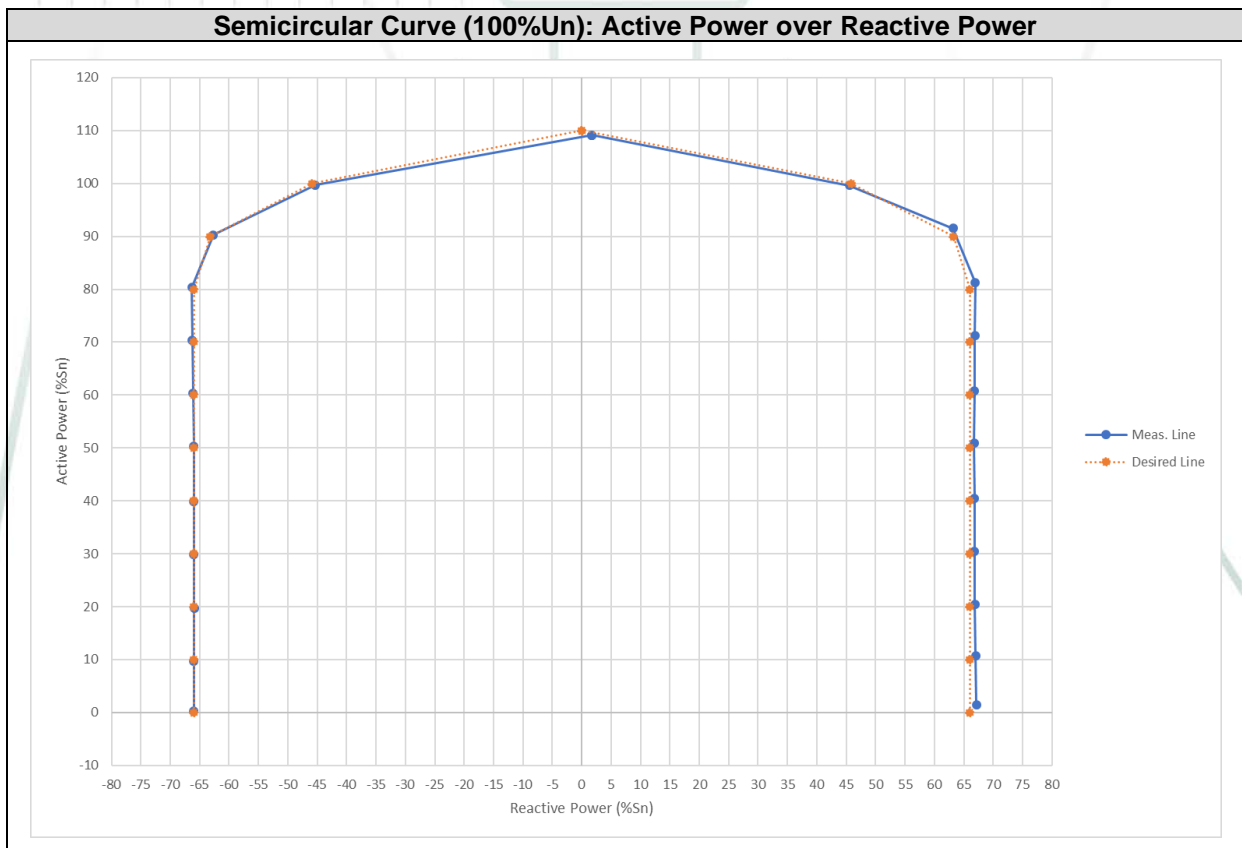
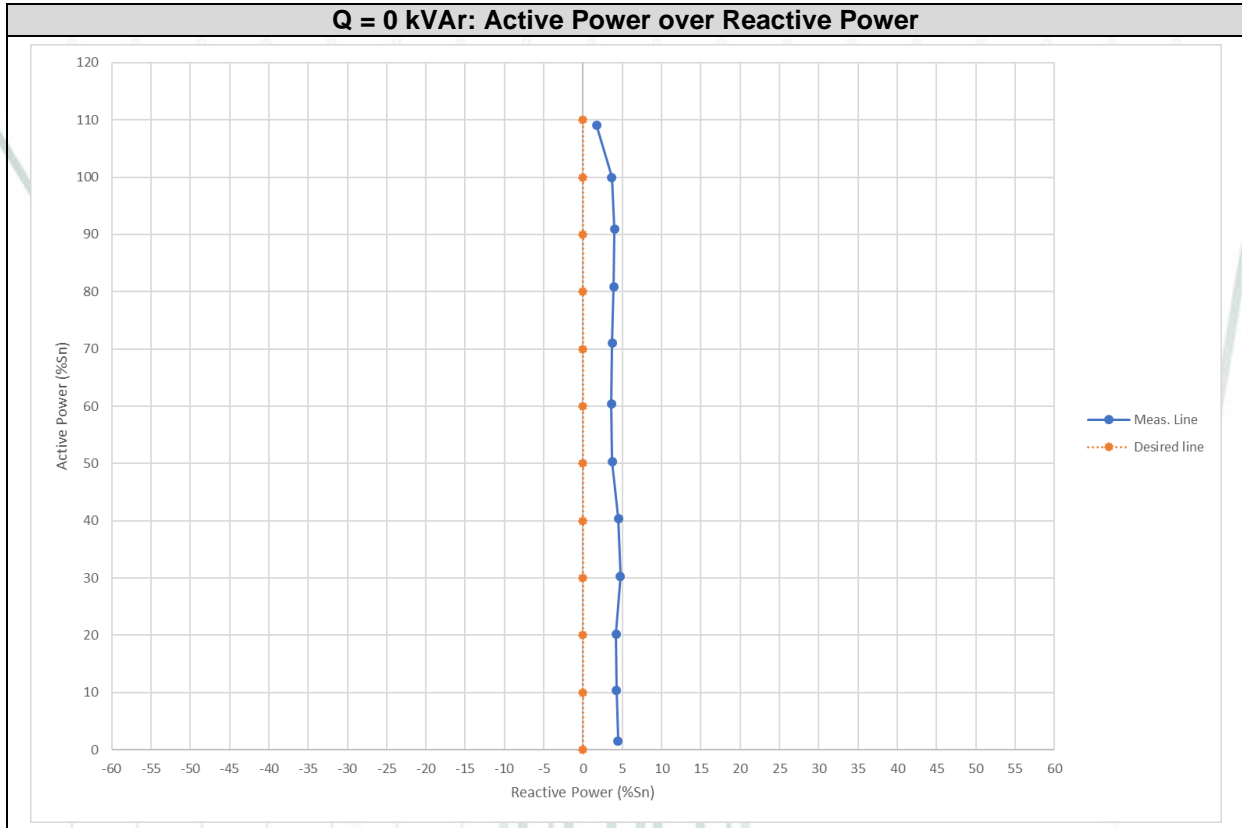

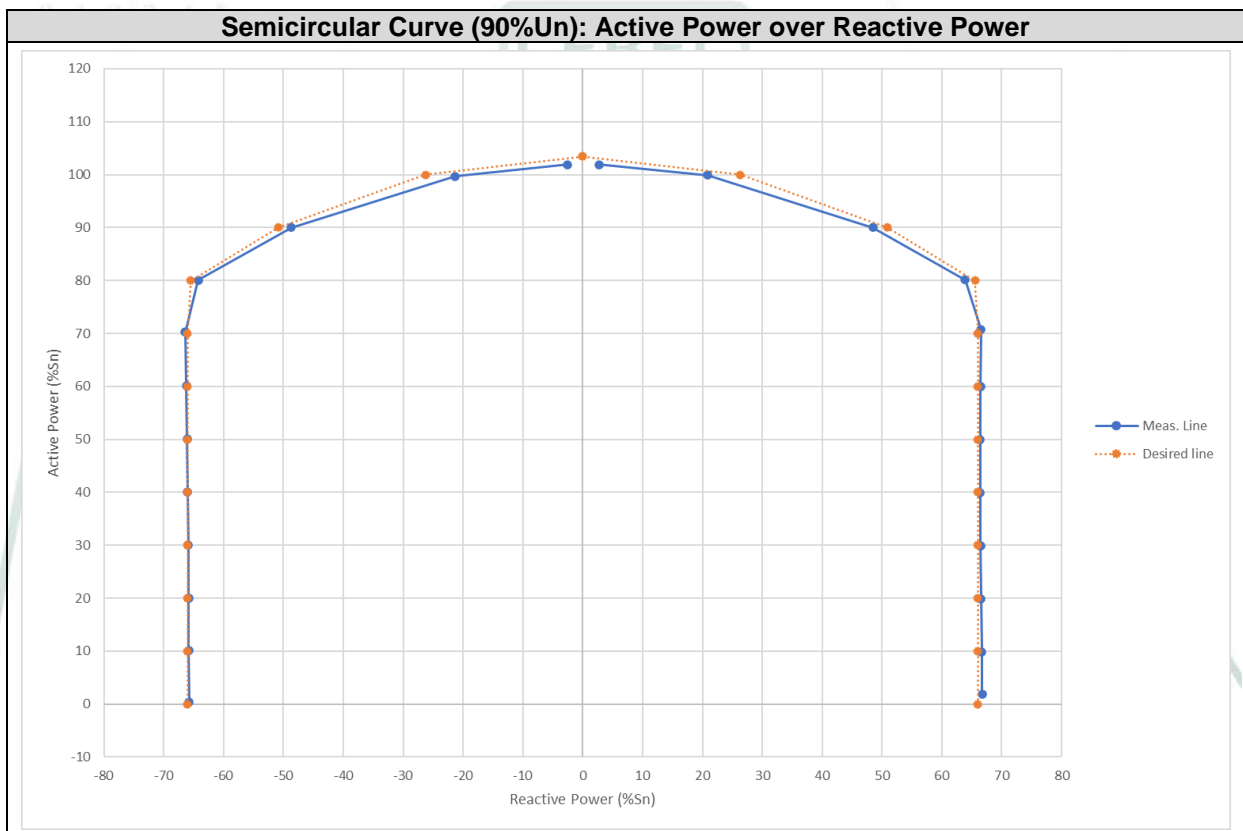
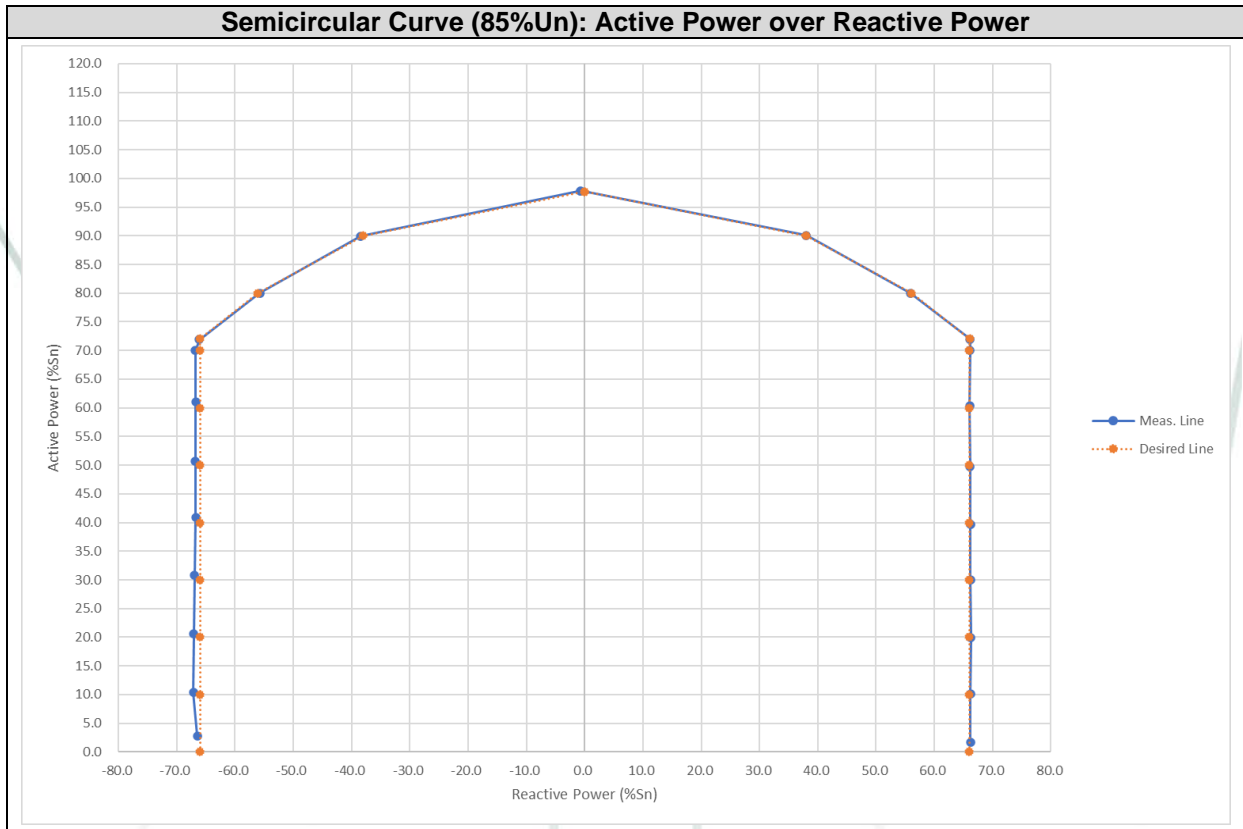

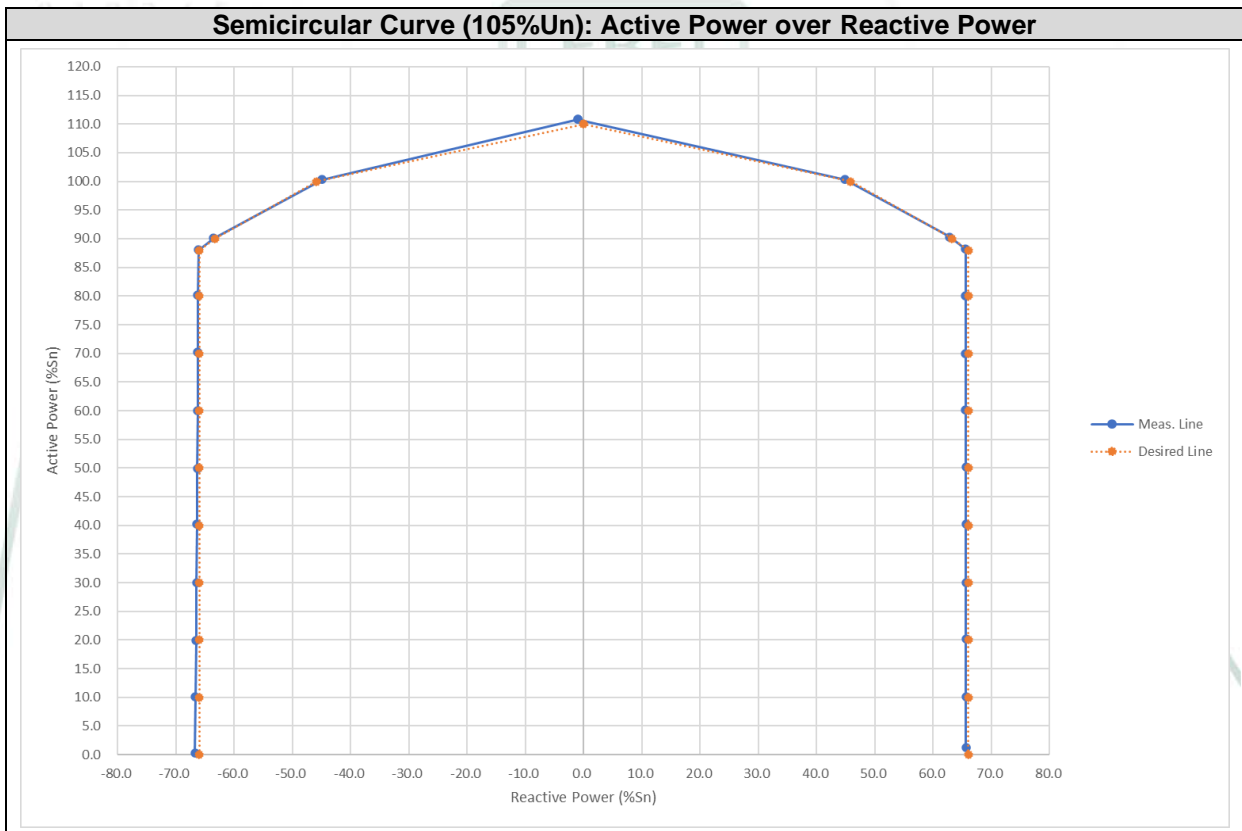
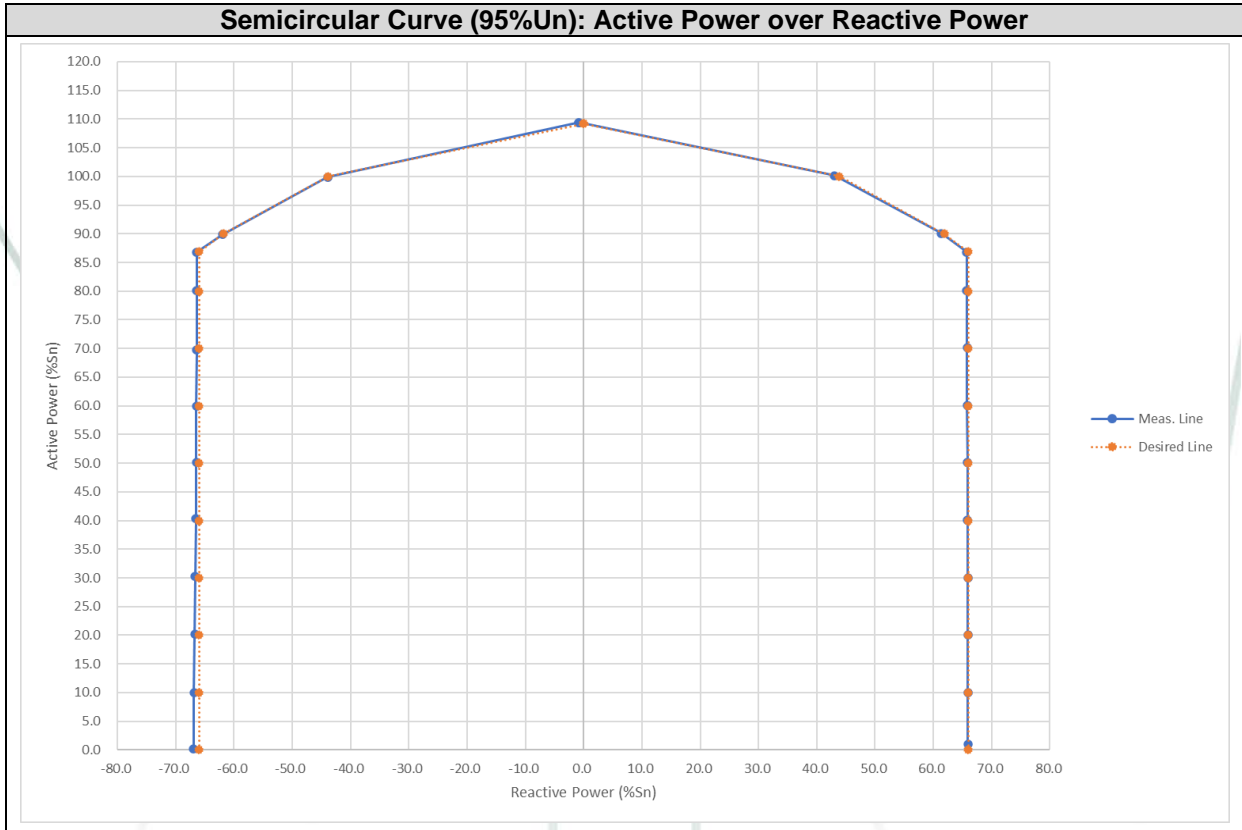

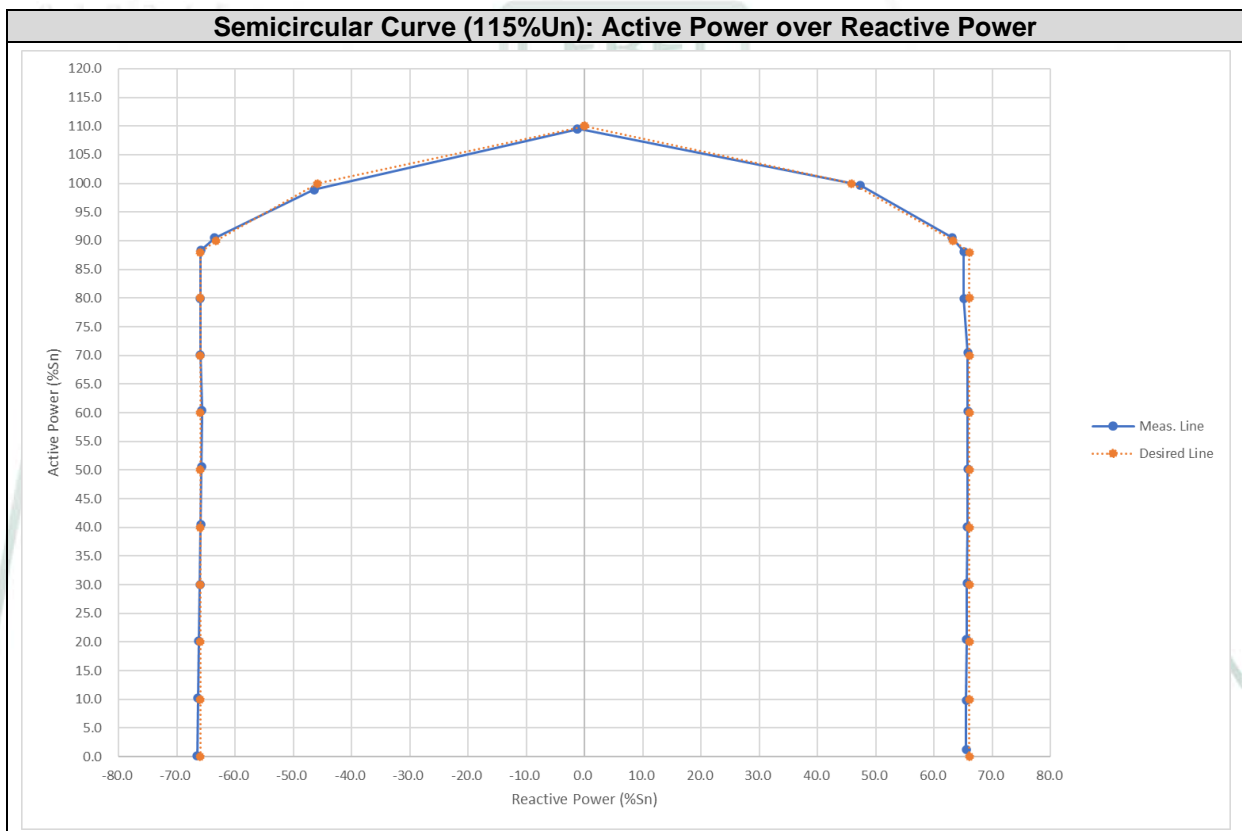
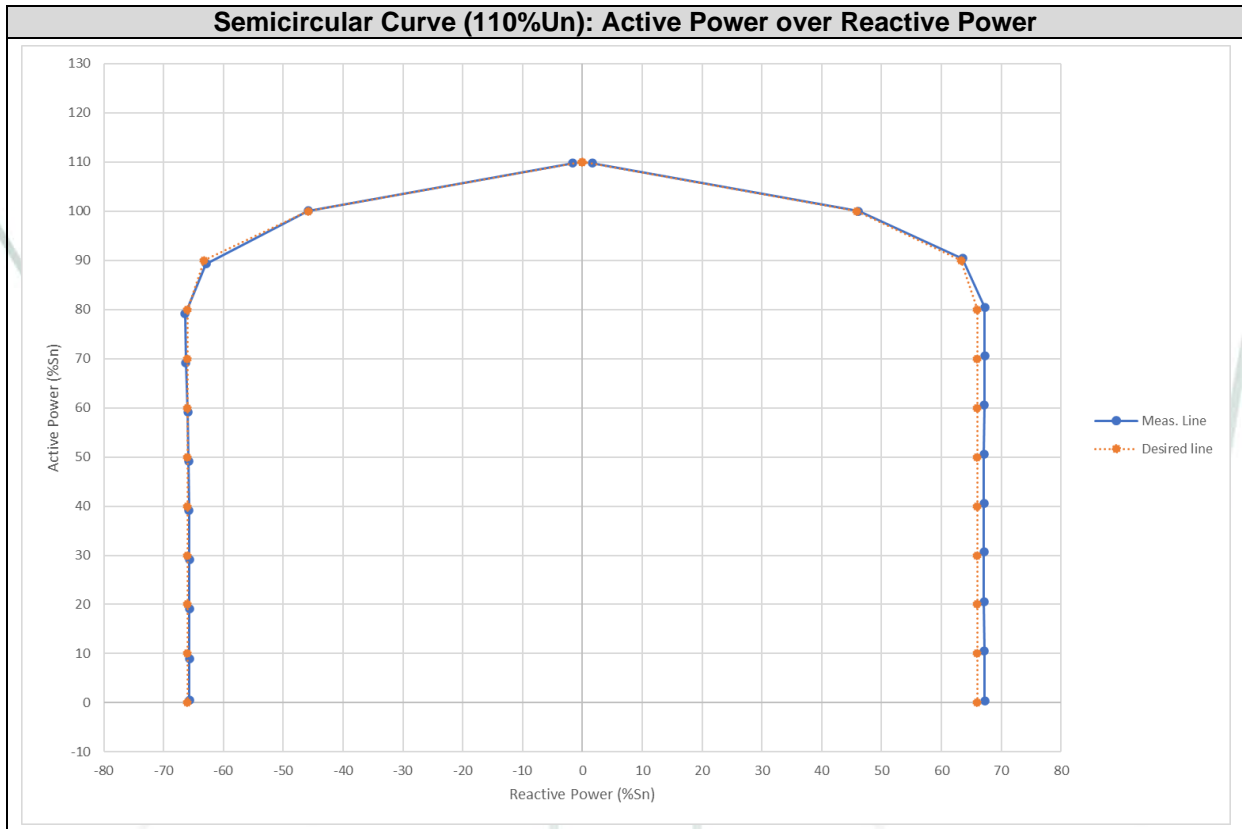

The tables below show measured values for each power step tested to verify the voltage-dependent PQ diagram at different ambient temperature conditions:

Semicircular Curve (U = 100% Un) – Inductive							
P Desired (%Pn)	P measured (kW)	Q measured (kVAr)	S measured (kVA)	S deviation (kVA)	Power Factor (cos φ)	V _{AC} + (V)	Number of records
0	0.709	+33.571	33.579	+0.579	0.021	229.7	900
10	5.327	+33.514	33.935	+0.558	0.157	229.8	900
20	10.227	+33.458	34.986	+0.505	0.292	229.8	900
30	15.255	+33.422	36.739	+0.490	0.415	229.8	900
40	20.265	+33.395	39.063	+0.475	0.519	229.9	900
50	25.456	+33.390	41.987	+0.586	0.606	229.9	900
60	30.413	+33.408	45.177	+0.579	0.673	229.9	900
70	35.630	+33.441	48.865	+0.761	0.729	230.0	900
80	40.610	+33.464	52.621	+0.766	0.772	230.0	900
90	45.751	+31.598	55.602	+0.602	0.823	230.0	900
100	49.820	+22.787	54.784	-0.216	0.909	230.1	900
110	54.572	+0.871	54.579	-0.421	1.000	230.7	900

Semicircular Curve (U = 100% Un) – Capacitive							
P Desired (%Pn)	P measured (kW)	Q measured (kVAr)	S measured (kVA)	S deviation (kVA)	Power Factor (cos φ)	V _{AC} + (V)	Number of records
0	0.160	-32.997	32.998	-0.002	0.005	230.3	900
10	4.814	-32.986	33.336	-0.041	0.144	230.3	900
20	9.866	-32.978	34.422	-0.059	0.287	230.3	900
30	14.902	-32.986	36.196	-0.053	0.412	230.3	900
40	19.905	-32.985	38.526	-0.062	0.517	230.4	900
50	25.169	-32.990	41.494	+0.094	0.607	230.4	900
60	30.171	-33.074	44.768	+0.170	0.674	230.4	900
70	35.171	-33.117	48.309	+0.205	0.728	230.5	900
80	40.178	-33.158	52.093	+0.238	0.771	230.5	900
90	45.134	-31.354	54.956	-0.044	0.821	230.5	900
100	49.848	-22.656	54.756	-0.244	0.910	230.5	900
110	54.546	+0.869	54.553	-0.447	1.000	230.7	900

Note: Test performed in active power priority mode. Maximum apparent power that can be reached corresponds to 110%Sn, approximately. Deviations are calculated in relation to this expected apparent power value, which is calculated from $S = \sqrt{P^2 + Q^2}$, where P is the setpoint value, and Q is the expected value defined by manufacturer.

Semicircular Curve (U = 85% Un) – Inductive ⁽¹⁾							
P Desired (%Pn)	P measured (kW)	Q measured (kVAr)	S measured (kVA)	S deviation (kVA)	Power Factor (cos φ)	V _{AC+} (V)	Number of records
0	0.837	+33.084	33.132	+0.132	0.025	196.2	1800
10	5.080	+33.088	33.507	+0.130	0.152	196.2	1800
20	9.996	+33.121	34.641	+0.159	0.289	196.2	1800
30	14.997	+33.098	36.378	+0.128	0.412	196.2	1800
40	19.821	+33.090	38.630	+0.043	0.513	196.2	1800
50	24.893	+33.046	41.437	+0.037	0.601	196.2	1800
60	30.173	+33.037	44.822	+0.223	0.673	196.2	1800
70	35.025	+33.056	48.250	+0.146	0.726	196.2	1800
72	35.970	+33.059	48.945	+0.108	0.735	196.2	1800
80	39.993	+27.926	48.876	+0.026	0.818	196.2	1800
90	45.025	+18.997	48.941	+0.091	0.920	196.2	1800
97.7	48.927	-0.341	48.932	+0.082	1.000	196.2	1800
100 ⁽²⁾	48.968	-0.351	48.992	+0.142	1.000	196.5	1800

Semicircular Curve (U = 85% Un) – Capacitive ⁽¹⁾							
P Desired (%Pn)	P measured (kW)	Q measured (kVAr)	S measured (kVA)	S deviation (kVA)	Power Factor (cos φ)	V _{AC+} (V)	Number of records
0	1.402	-33.225	33.279	+0.279	0.042	196.0	1800
10	5.177	-33.564	33.987	+0.611	0.152	196.1	1800
20	10.328	-33.540	35.114	+0.632	0.294	196.1	1800
30	15.382	-33.458	36.845	+0.596	0.417	196.1	1800
40	20.420	-33.360	39.194	+0.606	0.521	196.0	1800
50	25.320	-33.417	41.959	+0.559	0.603	196.1	1800
60	30.515	-33.383	45.269	+0.671	0.674	196.1	1800
70	34.998	-33.407	48.427	+0.323	0.723	196.1	1800
72	35.958	-33.056	48.889	+0.053	0.736	196.1	1800
80	40.008	-27.878	48.815	-0.035	0.820	196.1	1800
90	44.953	-19.220	48.933	+0.083	0.919	196.2	1800
97.7	48.930	-0.341	48.935	+0.085	1.000	196.2	1800
100 ⁽²⁾	48.950	-0.351	48.945	+0.095	1.000	196.0	1800

⁽¹⁾ Test performed in active power priority mode. Working at 85% Un the inverter does not reach the maximum 110% Sn due to the current limitation function. Maximum apparent power that can be reached corresponds to 97.7% Sn (48.85 kVA), approximately. Deviations are calculated in relation to this expected apparent power value, which is calculated from $S = \sqrt{P^2 + Q^2}$, where P is the setpoint valve, and Q is the excepted value defined by manufacturer. And the maximum apparent power was not reached below upper power levels due to maximum limitation in the Q capability.

⁽²⁾ The active power can't reach 100%Pn due to the current limitation function.

Semicircular Curve (U = 90% Un) – Inductive ⁽¹⁾							
P Desired (%Pn)	P measured (kW)	Q measured (kVAr)	S measured (kVA)	S deviation (kVA)	Power Factor (cos φ)	V _{AC+} (V)	Number of records
0	0.955	+33.380	33.394	+0.394	0.029	206.5	2400
10	4.914	+33.331	33.692	+0.315	0.146	206.5	2400
20	9.944	+33.278	34.732	+0.250	0.286	206.5	2400
30	14.966	+33.240	36.454	+0.205	0.411	206.6	2400
40	19.963	+33.216	38.753	+0.165	0.515	206.6	2400
50	24.979	+33.208	41.554	+0.153	0.601	206.6	2400
60	30.007	+33.228	44.772	+0.174	0.670	206.7	2400
70	35.361	+33.253	48.541	+0.437	0.728	206.7	2400
80	40.048	+31.937	51.223	-0.477	0.782	206.7	2400
90	45.018	+24.225	51.122	-0.578	0.881	206.8	2400
100	49.940	+10.438	51.019	-0.681	0.979	207.0	2400
110 ⁽²⁾	50.936	+1.379	50.955	-0.745	1.000	207.0	2400

Semicircular Curve (U = 90% Un) – Capacitive ⁽¹⁾							
P Desired (%Pn)	P measured (kW)	Q measured (kVAr)	S measured (kVA)	S deviation (kVA)	Power Factor (cos φ)	V _{AC+} (V)	Number of records
0	0.188	-32.886	32.886	-0.114	0.006	207.0	2400
10	5.082	-32.903	33.293	-0.083	0.153	207.0	2400
20	9.986	-32.930	34.410	-0.072	0.290	207.0	2400
30	15.007	-32.956	36.212	-0.037	0.414	207.1	2400
40	20.001	-32.997	38.585	-0.002	0.518	207.1	2400
50	25.041	-33.054	41.469	+0.068	0.604	207.2	2400
60	30.076	-33.126	44.743	+0.145	0.672	207.2	2400
70	35.119	-33.212	48.336	+0.232	0.727	207.2	2400
80	40.022	-32.128	51.322	-0.378	0.780	207.2	2400
90	44.989	-24.353	51.157	-0.543	0.879	207.2	2400
100	49.834	-10.651	50.960	-0.740	0.978	207.1	2400
110 ⁽²⁾	50.933	-1.307	50.949	-0.751	1.000	207.1	2400

⁽¹⁾ Test performed in active power priority mode. Working at 90% Un the inverter does not reach the maximum 110% Sn due to the current limitation function. Maximum apparent power that can be reached corresponds to 103.4%Sn (51.7 kVA), approximately. Deviations are calculated in relation to this expected apparent power value, which is calculated from $S = \sqrt{P^2 + Q^2}$, where P is the setpoint value, and Q is the expected value defined by manufacturer. And the maximum apparent power was not reached below upper power levels due to maximum limitation in the Q capability.

⁽²⁾ The active power can't reach 110%Pn due to the current limitation function.

Semicircular Curve (U = 95% Un) – Inductive ⁽¹⁾							
P Desired (%Pn)	P measured (kW)	Q measured (kVAr)	S measured (kVA)	S deviation (kVA)	Power Factor (cos φ)	V _{AC+} (V)	Number of records
0	0.508	+32.967	33.059	+0.059	0.015	218.2	1800
10	5.003	+32.968	33.417	+0.041	0.150	218.2	1800
20	10.016	+32.964	34.508	+0.026	0.290	218.2	1800
30	14.976	+32.959	36.250	+0.001	0.413	218.2	1800
40	20.023	+32.933	38.592	+0.004	0.519	218.2	1800
50	25.081	+32.916	41.439	+0.039	0.605	218.2	1800
60	30.030	+32.892	44.633	+0.035	0.673	218.2	1800
70	35.056	+32.884	48.174	+0.070	0.728	218.2	1800
80	40.038	+32.869	51.917	+0.061	0.771	218.3	1800
86.9	43.411	+32.871	54.569	+0.008	0.796	218.3	1800
90	45.032	+30.691	54.610	+0.010	0.825	218.3	1800
100	50.060	+21.526	54.576	-0.024	0.917	218.3	1800
109.2	54.688	-0.391	54.693	+0.093	1.000	218.7	1800
110 ⁽²⁾	54.707	-0.381	54.713	+0.113	1.000	218.8	1800

Semicircular Curve (U = 95% Un) – Capacitive ⁽¹⁾							
P Desired (%Pn)	P measured (kW)	Q measured (kVAr)	S measured (kVA)	S deviation (kVA)	Power Factor (cos φ)	V _{AC+} (V)	Number of records
0	0.078	-33.462	33.501	+0.501	0.002	218.1	1800
10	5.023	-33.443	33.848	+0.472	0.148	218.1	1800
20	10.080	-33.376	34.887	+0.405	0.289	218.1	1800
30	15.135	-33.339	36.635	+0.386	0.413	218.1	1800
40	20.157	-33.265	38.919	+0.332	0.518	218.1	1800
50	25.079	-33.242	41.679	+0.279	0.602	218.1	1800
60	29.986	-33.228	44.802	+0.204	0.669	218.2	1800
70	34.863	-33.215	48.200	+0.096	0.723	218.2	1800
80	40.037	-33.195	52.058	+0.202	0.769	218.2	1800
86.9	43.398	-33.191	54.685	+0.124	0.794	218.2	1800
90	44.937	-31.009	54.647	+0.047	0.822	218.2	1800
100	49.939	-21.953	54.595	-0.005	0.915	218.2	1800
109.2	54.688	-0.392	54.694	+0.094	1.000	218.7	1800
110 ⁽²⁾	54.692	-0.387	54.695	+0.095	1.000	218.6	1800

⁽¹⁾ Test performed in active power priority mode. Working at 95% Un the inverter does not reach the maximum 110% Sn due to the current limitation function. Maximum apparent power that can be reached corresponds to 109.2% Sn (54.6 kVA), approximately. Deviations are calculated in relation to this expected apparent power value, which is calculated from $S = \sqrt{P^2 + Q^2}$, where P is the setpoint value, and Q is the expected value defined by manufacturer. And the maximum apparent power was not reached below upper power levels due to maximum limitation in the Q capability.

⁽²⁾ The active power can't reach 110%Pn due to the current limitation function.

Semicircular Curve (U = 105% Un) – Inductive ⁽¹⁾							
P Desired (%Pn)	P measured (kW)	Q measured (kVAr)	S measured (kVA)	S deviation (kVA)	Power Factor (cos φ)	V _{AC+} (V)	Number of records
0	0.601	+32.809	32.922	-0.078	0.018	241.7	1800
10	5.020	+32.820	33.292	-0.085	0.151	241.7	1800
20	10.093	+32.803	34.392	-0.090	0.293	241.7	1800
30	15.012	+32.807	36.137	-0.112	0.415	241.7	1800
40	20.084	+32.808	38.524	-0.064	0.521	241.7	1800
50	25.057	+32.802	41.343	-0.058	0.606	241.7	1800
60	30.052	+32.786	44.583	-0.015	0.674	241.8	1800
70	34.982	+32.778	48.064	-0.040	0.728	241.8	1800
80	39.999	+32.764	51.838	-0.018	0.772	241.8	1800
88	44.102	+32.764	55.073	+0.073	0.801	241.8	1800
90	45.151	+31.427	55.143	+0.143	0.819	241.8	1800
100	50.155	+22.451	55.048	+0.048	0.911	241.8	1800
110	55.426	-0.500	55.434	+0.434	1.000	241.8	1800

Semicircular Curve (U = 105% Un) – Capacitive ⁽¹⁾							
P Desired (%Pn)	P measured (kW)	Q measured (kVAr)	S measured (kVA)	S deviation (kVA)	Power Factor (cos φ)	V _{AC+} (V)	Number of records
0	0.112	-33.361	33.404	+0.404	0.003	241.6	1800
10	5.035	-33.339	33.754	+0.377	0.149	241.6	1800
20	9.968	-33.271	34.761	+0.279	0.287	241.6	1800
30	14.972	-33.238	36.480	+0.231	0.410	241.7	1800
40	20.118	-33.187	38.835	+0.248	0.518	241.7	1800
50	24.950	-33.166	41.544	+0.144	0.601	241.7	1800
60	30.020	-33.136	44.760	+0.161	0.671	241.7	1800
70	35.094	-33.127	48.310	+0.206	0.726	241.7	1800
80	40.104	-33.109	52.057	+0.202	0.770	241.7	1800
88	44.015	-33.038	55.084	+0.084	0.799	241.7	1800
90	45.040	-31.768	55.166	+0.166	0.816	241.7	1800
100	50.177	-22.443	55.011	+0.011	0.912	241.7	1800
110	55.420	-0.499	55.429	+0.429	1.000	241.8	1800

⁽¹⁾ Test was performed in active power priority mode. Maximum apparent power that can be reached corresponds to 110%Sn (55 kVA), approximately. Deviations are calculated in relation to this expected apparent power value, which is calculated from $S = \sqrt{(P^2 + Q^2)}$, where P is the setpoint value, and Q is the expected value defined by manufacturer. And the maximum apparent power was not reached below upper power levels due to maximum limitation in the Q capability.

Semicircular Curve (U = 110% Un) – Inductive ⁽¹⁾							
P Desired (%Pn)	P measured (kW)	Q measured (kVAr)	S measured (kVA)	S deviation (kVA)	Power Factor (cos φ)	V _{AC+} (V)	Number of records
0	0.172	+33.602	33.602	+0.602	0.005	251.4	1800
10	5.261	+33.568	33.978	+0.601	0.155	251.7	1800
20	10.291	+33.552	35.095	+0.613	0.293	251.9	1800
30	15.321	+33.536	36.870	+0.621	0.416	252.2	1800
40	20.320	+33.546	39.220	+0.632	0.518	252.4	1800
50	25.292	+33.554	42.018	+0.618	0.602	252.6	1800
60	30.262	+33.576	45.201	+0.603	0.670	252.8	1800
70	35.255	+33.607	48.706	+0.602	0.724	252.9	1800
80	40.240	+33.605	52.427	+0.572	0.768	253.0	1800
90	45.216	+31.771	55.262	+0.262	0.818	253.0	1800
100	50.009	+23.058	55.068	+0.068	0.908	253.1	1800
110	54.904	+0.846	54.910	-0.090	1.000	253.7	1800

Semicircular Curve (U = 110% Un) – Capacitive ⁽¹⁾							
P Desired (%Pn)	P measured (kW)	Q measured (kVAr)	S measured (kVA)	S deviation (kVA)	Power Factor (cos φ)	V _{AC+} (V)	Number of records
0	0.265	-32.837	32.838	-0.162	0.008	252.2	1800
10	4.501	-32.842	33.149	-0.228	0.136	252.4	1800
20	9.547	-32.861	34.219	-0.262	0.279	252.7	1800
30	14.558	-32.861	35.942	-0.307	0.405	252.9	1800
40	19.568	-32.868	38.252	-0.335	0.512	253.1	1800
50	24.576	-32.925	41.086	-0.315	0.598	253.2	1800
60	29.584	-32.993	44.314	-0.284	0.668	253.3	1800
70	34.546	-33.152	47.880	-0.224	0.722	253.4	1800
80	39.563	-33.228	51.666	-0.190	0.766	253.4	1800
90	44.641	-31.472	54.620	-0.380	0.817	253.5	1800
100	50.040	-22.919	55.039	+0.039	0.909	253.5	1800
110	54.901	-0.845	54.908	-0.092	1.000	253.7	1800

⁽¹⁾ Test performed in active power priority mode. Maximum apparent power that can be reached corresponds to 110%Sn, approximately. Deviations are calculated in relation to this expected apparent power value, which is calculated from $S = \sqrt{P^2 + Q^2}$, where P is the setpoint value, and Q is the expected value defined by manufacturer. And the maximum apparent power was not reached below upper power levels due to maximum limitation in the Q capability.

Semicircular Curve (U = 115% Un) – Inductive ⁽¹⁾							
P Desired (%Pn)	P measured (kW)	Q measured (kVAr)	S measured (kVA)	S deviation (kVA)	Power Factor (cos φ)	V _{AC+} (V)	Number of records
0	0.649	+32.732	32.900	-0.100	0.020	265.1	1800
10	4.918	+32.740	33.247	-0.129	0.148	265.1	1800
20	10.214	+32.780	34.451	-0.031	0.296	265.1	1800
30	15.158	+32.824	36.258	+0.009	0.418	265.1	1800
40	20.057	+32.832	38.569	-0.019	0.520	265.1	1800
50	25.102	+32.865	41.457	+0.056	0.606	265.1	1800
60	30.115	+32.885	44.707	+0.109	0.674	265.2	1800
70	35.248	+32.895	48.340	+0.236	0.729	265.2	1800
80	39.975	+32.544	51.747	-0.109	0.773	265.1	1800
88	44.055	+32.528	54.961	-0.039	0.802	265.1	1800
90	45.294	+31.535	54.963	-0.037	0.809	265.1	1800
100	49.840	+23.643	55.301	+0.301	0.901	265.1	1800
110	54.750	-0.629	54.784	-0.216	0.999	265.1	1800

Semicircular Curve (U = 115% Un) – Capacitive ⁽¹⁾							
P Desired (%Pn)	P measured (kW)	Q measured (kVAr)	S measured (kVA)	S deviation (kVA)	Power Factor (cos φ)	V _{AC+} (V)	Number of records
0	0.047	-33.253	33.352	+0.352	0.001	265.0	1800
10	5.140	-33.183	33.667	+0.290	0.153	265.0	1800
20	10.119	-33.108	34.694	+0.212	0.292	265.0	1800
30	14.997	-33.015	36.333	+0.084	0.413	265.0	1800
40	20.249	-32.957	38.749	+0.162	0.523	265.1	1800
50	25.276	-32.874	41.541	+0.141	0.608	265.0	1800
60	30.222	-32.838	44.709	+0.111	0.676	265.1	1800
70	35.052	-32.975	48.251	+0.147	0.726	265.0	1800
80	39.961	-32.968	51.935	+0.079	0.769	265.1	1800
88	44.158	-32.948	55.221	+0.221	0.800	265.1	1800
90	45.266	-31.743	55.107	+0.107	0.807	265.1	1800
100	49.437	-23.215	55.347	+0.347	0.884	265.0	1800
110	54.732	-0.638	54.768	-0.232	0.999	265.1	1800

⁽¹⁾ Test was performed in active power priority mode. Maximum apparent power that can be reached corresponds to 110%Sn (55 kVA), approximately. Deviations are calculated in relation to this expected apparent power value, which is calculated from $S = \sqrt{(P^2 + Q^2)}$, where P is the setpoint value, and Q is the expected value defined by manufacturer. And the maximum apparent power was not reached below upper power levels due to maximum limitation in the Q capability.

2.4 Protection system

2.4.1 Trennung der EZE vom Netz / Cut-off from grid

<input checked="" type="checkbox"/> Die Überprüfung der Gesamtwirkungskette führte zu einer erfolgreichen Abschaltung. The test of the whole trip circuit led to a successful shut down							
	Einstellwert Setting In pu oder/or [Hz]		Auslösewert / Release value In pu oder/or [Hz]		Abschaltzeit / Disconnection time [ms]		Rückfallverhältnis Disengaging ratio
	Schwelle / value	Zeit / time	Min.	Max.	Min.	Max.	
Spannungssteigerungsschutz/ Overvoltage protection: U>	1.000	180.00 s	1.003	1.008	180.00 s	180.00 s	☒ ≥0.98 ☐ <0.98
	1.300	0.040 s	1.301	1.306	0.022 s	0.030 s	
Spannungssteigerungsschutz/ Overvoltage protection: U>>	1.000	180.00 s	1.003	1.008	180.00 s	180.00 s	---
	1.300	0.050 s	1.301	1.308	0.051 s	0.072 s	
Spannungsrückgangsschutz/ Undervoltage protection: U<	0.100	0.040 s	0.095	0.100	0.045 s	0.053 s	☒ ≤1.02 ☐ >1.02
	1.000	2.400 s	0.994	1.001	2.364 s	2.394 s	
Spannungsrückgangsschutz/ Undervoltage protection: U<<	0.100	0.100 s	0.095	0.100	0.094 s	0.100 s	☒ ≤1.02 ☐ >1.02
	1.000	0.900 s	0.998	1.001	0.871 s	0.896 s	
Frequenzsteigerungsschutz/ Overfrequency protection: F>	50.00	5.000 s	50.03		4.986 s		---
	55.00	0.040 s	55.04		0.049 s		
Frequenzsteigerungsschutz/ Overfrequency protection: F>>	50.00	5.000 s	50.02		4.971 s		---
	55.00	0.040 s	55.05		0.049 s		
Frequenzrückgangsschutz/ Underfrequency protection: F<	45.00	0.040 s	44.99		0.050 s		---
	50.00	0.100 s	49.96		0.084 s		
Eigenzeit der Abschalteneinheit / Operating time of a circuit breaker:	<input checked="" type="checkbox"/> aus Messung by measurement				<input type="checkbox"/> aus Prüfcertifikat by test certificate		
	According to the point 4.4.1 of the test report no. 2221/0015, the measured circuit breaker operating time is 10 ms						

Note: Results given are obtained after test results performed on the model SG50CX. STP. These test results for the model SG50CX can be transferred to derived models SG33CX and SG40CX, considering the evaluation offered in the point 1.2 of this document.

2.4.2 Zuschaltbedingungen / Cut-in conditions

- For VDE-AR-N 4110: 2018-11

	Bereich / range In pu order/ or [Hz]	Zuschaltung erfolgte im angegebenen Bereich / cut in occurred within the given range	
Zpannung / Voltage:	0.90 – 1.10	<input type="checkbox"/> nein / no	<input checked="" type="checkbox"/> ja / yes
Frequenz / Frequency:	47.5 – 50.2	<input type="checkbox"/> nein / no	<input checked="" type="checkbox"/> ja / yes

Note: Results given are obtained after test results performed on the model SG50CX. STP. These test results for the model SG50CX can be transferred to derived models SG33CX and SG40CX, considering the evaluation offered in the point 1.2 of this document.

2.4.3 Zuschaltbedingungen nach Auslösung des Entkupplungsschutzes / Cut-in conditions after tripping of protection

	Bereich / range In pu order/ or [Hz]	Zuschaltung erfolgte im angegebenen Bereich cut in occurred within the given range	
Unterspannung / Undervoltage:	> 0.95	<input type="checkbox"/> nein / no	<input checked="" type="checkbox"/> ja / yes
Unterfrequenz / Underfrequency:	≥ 49.9	<input type="checkbox"/> nein / no	<input checked="" type="checkbox"/> ja / yes
Überfrequenz / Overfrequency:	≤ 50.1	<input type="checkbox"/> nein / no	<input checked="" type="checkbox"/> ja / yes

As evidenced in the FGW TG3 test report, the certified unit follows a ramp gradient inside of the range 33%Pn/s – 66%Pn/s after the reconnection occurs.

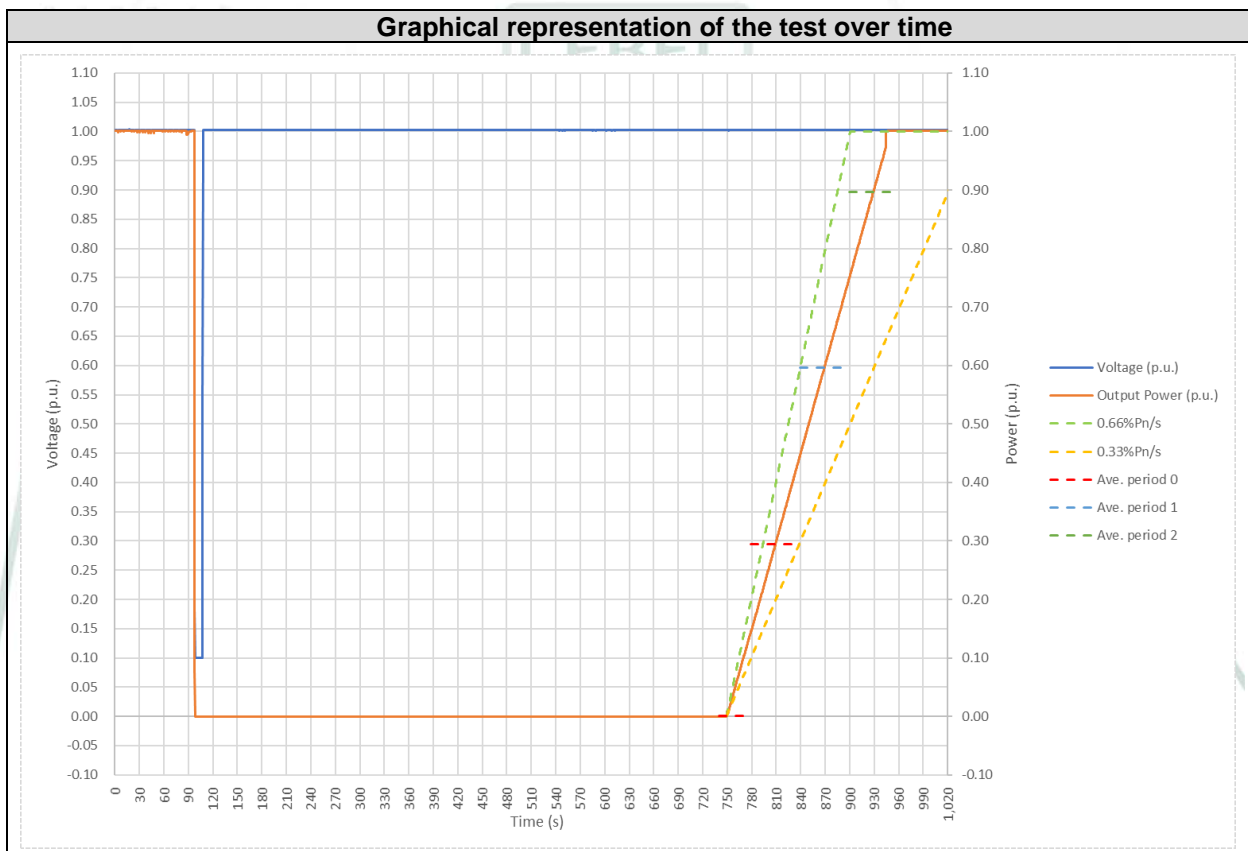

Note: Results given are obtained after test results performed on the model SG50CX. STP. These test results for the model SG50CX can be transferred to derived models SG33CX and SG40CX, considering the evaluation offered in the point 1.2 of this document.

2.5 Response during grid faults

The compliance with these requirements including all calculations defined in the FGW TR3 standard is stated in the attachment to the test report:

- 2221 / 0015 (Rev 2) ATTACHMENT I : FGW-TG3: Grid Fault Tests Results

Note: Results given are obtained after test results performed on the model SG50CX. STP. These test results for the model SG50CX can be transferred to derived models SG33CX and SG40CX, considering the evaluation offered in the point 1.2 of this document.

The instantaneous values of AC currents and voltages are recorded synchronously with 50kHz (20 μ s). Positives sequence component are based on measurement of instantaneous voltages and currents are calculated according to IEC 61400-21 (2008).

The following table shows the declared short-circuit values for certified models and can be applied to Annex E.5 of the VDE norm.

- For SG33CX:
 - Short-circuit surge current i_P (A): 104 A.
 - Initial symmetrical short-circuit current I_k'' (A): 61 A
 - Uninterrupted short-circuit current I_k (A): 55.2 A.
 - Maximal current I_{max} (A): 55.2 A.
 - R.m.s. value of the source current for three-phase fault, I_{skPF} (First 1-2 cycles of the Fault) = 61 A
 - R.m.s. value of the source current for two-phase fault, $I(1)_{sk2PF}$ (First 1-2 cycles of the Fault) = 55 A
 - R.m.s. value of the source current for single-phase fault, $I(1)_{sk1PF}$ (First 1-2 cycles of the Fault)= 49.4 A.
- For SG40CX:
 - Short-circuit surge current i_P (A): 125 A.
 - Initial symmetrical short-circuit current I_k'' (A): 73 A
 - Uninterrupted short-circuit current I_k (A): 66.9 A.
 - Maximal current I_{max} (A): 66.9 A.
 - R.m.s. value of the source current for three-phase fault, I_{skPF} (First 1-2 cycles of the Fault) = 73 A
 - R.m.s. value of the source current for two-phase fault, $I(1)_{sk2PF}$ (First 1-2 cycles of the Fault) = 66 A
 - R.m.s. value of the source current for single-phase fault, $I(1)_{sk1PF}$ (First 1-2 cycles of the Fault)= 61.2 A.
- For SG50CX:
 - Short-circuit surge current i_P (A): 157 A.
 - Initial symmetrical short-circuit current I_k'' (A): 92 A
 - Uninterrupted short-circuit current I_k (A): 83.6 A.
 - Maximal current I_{max} (A): 83.6 A.
 - R.m.s. value of the source current for three-phase fault, I_{skPF} (First 1-2 cycles of the Fault) = 92 A
 - R.m.s. value of the source current for two-phase fault, $I(1)_{sk2PF}$ (First 1-2 cycles of the Fault) = 82 A
 - R.m.s. value of the source current for single-phase fault, $I(1)_{sk1PF}$ (First 1-2 cycles of the Fault)= 73.4 A.

Negative sequence short circuit impedance for all integer K factors is 1.618~9999 p.u. @stable status.

3 OVERVIEW OF RESULTS OF THE FGW TR4 VALIDATION REPORT

Report Number: 2221 / 0015 – E1 - TG4 with date 2021-08-12 according FGW TR4 rev. 9.

Software Characteristics

- Software type: Simulator for Grid Connected Power Conversion System
- Simulation platform: DigSilent PowerFactory
- Used version of the simulation platform: 20.0.3_A2 (*)
- Simulation Software File identification: VDE_SG50CX_Pf2018
- Dynamic Simulation Model version: V1
- MD5 Checksum: 7B9D30E70806F960D35E473F05C68EC6

(*) Simulation results offered in the validation report were obtained with the Powerfactory Digsilent Version 20.0.3_A2. The validation report doesn't cover upper version of Digsilent above V20.0.3_A2.

Revision 3

Report Number: 2221/0015-E1/A-TG4 demonstrates that the updated Dynamic Simulation Model (version 3.2) does not show any critical change compared to the previous version used in the original report number 2221/0015-E1-TG4. For more details see clause 3.1.3 of this Annex to Certificate

Software Characteristics used on Test Report 2221/0015-E1/A-TG4

- Validation report number: 2221/0015-E1/A-TG4
- Issuance date: 20-01-2022
- Issued by: SGS Tecnos, S.A. (Electrical Testing Laboratory)
- Simulation model name: VDE_SG33_40_50CX_Pf2018
- Version of the simulation model: V3.2
- MD5 Checksum: F35B4A3146CD2FCEC35D1012BD8646E8
- Simulation platform: DigSilent PowerFactory 2021 SP4B
- Simulation platform version: 21.0.6.0 (11021) / Rev 83448 (*)

(*) Simulation results offered in the validation report were obtained with the Powerfactory Digsilent Version 21.0.6.0. The validation report doesn't cover upper version of Digsilent above Version 21.0.6.0.

The model is in accordance with the requirements of the clause 5 of FGW TR4 rev.9. The validation of the dynamic simulation model has been performed in order to be compliant with evaluations required in the point 2.3.3 of the standard FGW TR8, rev9.

Requirements of the clause 11.2.6.3 of the standard VDE-AR-N 4110: 2018 have been considered for the evaluation process.

Deviations evaluated for MXE, ME and MAE calculations are in accordance with the chapter 5.3 of FGW TR4 rev.9.

The validation plan is according with the chapter 5.1 of FGW TR4 rev.9. where following tests have been used for validation:

- Validation requirements for voltage ride through:
This involves the validation of symmetrical and asymmetrical test cases defined in the table 4-69 of the chapter 4.6.3 of FGW TR3 rev.25 for Type 2 PGUs.
- Validation of P and Q setpoint control functions
This involves the validation of the dynamic response of the simulation model in front of P and Q changes commanded by set point. Test requirements offered in the chapter 4.2.4 of FGW TR3 rev.25 are considered.
- Validation requirements for reactive power control processes:
This involves the validation of accuracy requirements defined in chapters 4.2.5 (Q vs U) and 4.2.6 (Q vs P) of FGW TR3 rev.25.
- Verification of requirements for protective settings:

This involves the verification of the parameters for protection devices and settings declared by default for the certified product.

The validation overview for VRT cases is compliant with the Annex A.1.1, included in the report and compared with the validation overview in accordance with the table A-1. See FRT validation results in the point 2.1 of this document.

The main validation process detailed in the above referred report has been performed over the dynamic simulation model for SG50CX. In addition, for this model, it has been performed the full list additional plausibility tests in accordance with the chapter 5.5 of FGW TR4 rev.9.

Apart of this, in order to verify the transferability of validation results to derived models, they have also been completed following simulation cases over the dynamic simulation model of SG50CX adapted to operate with generation capabilities of derived models SG40CX and SG33CX. See the information given in the point 1.4 of this document for further information.

- Verification of Voltage-Dependent PQ diagrams.
- Performance of some aleatory plausibility test cases.

See further information of the dynamic simulation model and the software used in the point 4 of this annex.

0 1 2 3 4 5



3.1 Validation results

3.1.1 Validation overview

The following table shows the FRT validation results in terms of deviations as defined by the standard for the positive and negative sequences of currents and powers in symmetrical and asymmetrical fault conditions at nominal and partial power.

All deviations are in accordance to the regular maximum tolerances given by the standard.

Test designation compliant with TR3, Chapter 4.6 Response during grid faults. Table 4-67			Three phase voltage drops in Positive phase sequence system											
			P			Q			Ia			Iq		
			MXE	ME	MAE	MXE	ME	MAE	MXE	ME	MAE	MXE	ME	MAE
0.20≤Ures≤0.30	In accordance with IEC	Pre	0.0079	0.0027	0.0030	0.0017	0.0005	0.0006	0.0190	0.0136	0.0136	0.0016	0.0004	0.0006
25.1		Fault	0.0045	-0.0059	0.0013	0.0064	-0.0009	0.0054	0.0174	-0.0054	0.0051	0.0195	0.0047	0.0176
3ph/100%/2		Post	0.0124	0.0006	0.0077	0.0430	-0.0103	0.0113	0.0234	0.0111	0.0182	0.0430	-0.0090	0.0112
0.20≤Ures≤0.30	In accordance with IEC	Pre	0.0027	-0.0020	0.0020	0.0004	0.0000	0.0001	0.0029	-0.0021	0.0021	0.0005	0.0000	0.0001
25.2		Fault	0.0099	-0.0059	0.0063	0.0123	-0.0073	0.0113	0.0375	-0.0162	0.0234	0.0196	0.0018	0.0178
3ph/20%/2		Post	0.0108	0.0021	0.0037	0.0401	-0.0097	0.0101	0.0106	0.0020	0.0036	0.0401	-0.0082	0.0100
0.45≤Ures≤0.60	In accordance with IEC	Pre	0.0071	0.0023	0.0028	0.0022	0.0010	0.0010	0.0119	0.0070	0.0070	0.0022	0.0010	0.0010
50.1		Fault	0.0046	-0.0054	0.0028	0.0352	-0.0287	0.0334	0.0096	-0.0085	0.0060	0.0778	-0.0637	0.0736
3ph/100%/2		Post	0.0089	-0.0059	0.0111	0.0342	-0.0074	0.0092	0.0147	-0.0011	0.0156	0.0341	-0.0066	0.0096
0.45≤Ures≤0.60	In accordance with IEC	Pre	0.0027	-0.0021	0.0021	0.0006	0.0001	0.0002	0.0027	-0.0021	0.0021	0.0006	0.0001	0.0002
50.2		Fault	0.0048	-0.0031	0.0032	0.0333	-0.0279	0.0315	0.0090	-0.0049	0.0058	0.0546	-0.0451	0.0528
3ph/20%/2		Post	0.0131	0.0028	0.0040	0.0375	-0.0085	0.0087	0.0131	0.0028	0.0039	0.0374	-0.0076	0.0092
0.45≤Ures≤0.60	In accordance with IEC	Pre	0.0044	-0.0003	0.0021	0.0016	0.0003	0.0005	0.0144	0.0101	0.0101	0.0015	0.0002	0.0005
50.5		Fault	0.0126	-0.0154	0.0121	0.0060	0.0055	0.0045	0.0253	-0.0283	0.0242	0.0121	0.0110	0.0089
3ph/20%/2L		Post	0.0092	-0.0084	0.0103	0.0346	-0.0079	0.0086	0.0181	0.0022	0.0184	0.0346	-0.0080	0.0086
0.70≤Ures≤0.80	In accordance with IEC	Pre	0.0094	0.0040	0.0041	0.0016	-0.0003	0.0006	0.0209	0.0153	0.0153	0.0017	-0.0004	0.0006
75.1		Fault	0.0190	-0.0186	0.0172	0.0419	-0.0369	0.0390	0.0254	-0.0245	0.0229	0.0545	-0.0470	0.0498
3ph/100%/2		Post	0.0101	-0.0048	0.0126	0.0353	-0.0088	0.0090	0.0219	0.0068	0.0243	0.0352	-0.0087	0.0092
0.70≤Ures≤0.80	In accordance with IEC	Pre	0.0030	-0.0021	0.0021	0.0005	0.0001	0.0002	0.0021	-0.0012	0.0012	0.0004	0.0001	0.0001
75.2		Fault	0.0033	-0.0025	0.0022	0.0383	-0.0343	0.0362	0.0042	-0.0030	0.0028	0.0489	-0.0433	0.0458
3ph/20%/2		Post	0.0167	0.0042	0.0047	0.0338	-0.0076	0.0079	0.0176	0.0052	0.0057	0.0338	-0.0075	0.0080
0.70≤Ures≤0.80	In accordance with IEC	Pre	0.0034	-0.0026	0.0026	0.0006	0.0001	0.0002	0.0024	-0.0016	0.0016	0.0007	-0.0003	0.0003
75.3		Fault	0.0032	-0.0022	0.0020	0.0486	-0.0444	0.0465	0.0046	-0.0031	0.0030	0.0692	-0.0629	0.0657
3ph/20%/2		Post	0.0077	0.0019	0.0024	0.0962	-0.0213	0.0214	0.0089	0.0030	0.0034	0.0965	-0.0216	0.0219
0.70≤Ures≤0.80	In accordance with IEC	Pre	0.0021	0.0015	0.0015	0.0009	0.0002	0.0003	0.0030	0.0023	0.0023	0.0012	0.0005	0.0005
75.4		Fault	0.0050	-0.0031	0.0029	0.0272	-0.0245	0.0259	0.0059	-0.0032	0.0030	0.0254	-0.0223	0.0242
3ph/20%/2		Post	0.0091	0.0024	0.0030	0.0418	0.0078	0.0089	0.0099	0.0033	0.0039	0.0421	0.0083	0.0093
0.70≤Ures≤0.80	In accordance with IEC	Pre	0.0007	0.0001	0.0002	0.0004	-0.0001	0.0001	0.0016	0.0009	0.0009	0.0005	-0.0001	0.0002
75.5		Fault	0.0076	-0.0049	0.0052	0.0549	-0.0492	0.0522	0.0101	-0.0064	0.0068	0.0702	-0.0622	0.0663
3ph≥10%/4		Post	0.0084	0.0043	0.0053	0.0395	-0.0092	0.0095	0.0093	0.0052	0.0061	0.0396	-0.0090	0.0099

Test designation compliant with TR3, Chapter 4.6 Response during grid faults. Table 4-67			Three phase voltage drops in Positive phase sequence system											
			P			Q			Ia			Iq		
			MXE	ME	MAE	MXE	ME	MAE	MXE	ME	MAE	MXE	ME	MAE
0.75 ≤ Ures ≤ 0.85 80.1 3ph/100%/2L	In accordance with IEC	Pre	0.0088	0.0033	0.0035	0.0022	0.0009	0.0009	0.0195	0.0139	0.0139	0.0021	0.0008	0.0008
		Fault	0.0161	-0.0155	0.0146	0.0452	-0.0421	0.0438	0.0202	-0.0195	0.0183	0.0576	-0.0540	0.0562
		Post	0.0100	-0.0044	0.0114	0.0340	-0.0077	0.0093	0.0221	0.0067	0.0225	0.0339	-0.0077	0.0092
0.85 ≤ Ures ≤ 0.90 85.1 3ph/100%/2	In accordance with IEC	Pre	0.0094	0.0039	0.0040	0.0016	0.0004	0.0006	0.0146	0.0088	0.0088	0.0016	0.0003	0.0005
		Fault	0.0137	-0.0121	0.0120	0.0321	-0.0293	0.0293	0.0161	-0.0141	0.0140	0.0371	-0.0323	0.0324
		Post	0.0098	-0.0042	0.0110	0.0347	-0.0083	0.0091	0.0160	0.0016	0.0168	0.0346	-0.0083	0.0091
Ures ≥ 1.15 115.1 3ph/100%/2	In accordance with IEC	Pre	0.0086	-0.0038	0.0038	0.0012	-0.0003	0.0004	0.0052	-0.0005	0.0015	0.0012	-0.0003	0.0004
		Fault	0.0588	0.0073	0.0105	0.1567	-0.0051	0.0065	0.0483	0.0084	0.0097	0.1365	-0.0046	0.0057
		Post	0.0525	0.0235	0.0239	0.0117	-0.0080	0.0081	0.0544	0.0263	0.0266	0.0114	-0.0078	0.0079
Ures ≥ 1.15 115.2 3ph/20%/2	In accordance with IEC	Pre	0.0039	-0.0031	0.0031	0.0004	0.0000	0.0001	0.0029	-0.0022	0.0022	0.0004	-0.0000	0.0001
		Fault	0.0032	0.0016	0.0020	0.0922	-0.0909	0.0910	0.0027	-0.0007	0.0003	0.0765	-0.0750	0.0750
		Post	0.0782	0.0308	0.0308	0.0306	-0.0056	0.0071	0.0791	0.0315	0.0316	0.0307	-0.0056	0.0070
Ures ≥ 1.10 110.3 3ph ≥ 10%/2	In accordance with IEC	Pre	0.0013	-0.0007	0.0007	0.0004	0.0001	0.0002	0.0007	-0.0000	0.0002	0.0004	0.0001	0.0001
		Fault	0.0025	-0.0014	0.0014	0.0717	-0.0701	0.0701	0.0041	-0.0031	0.0031	0.0622	-0.0605	0.0605
		Post	0.0479	0.0144	0.0152	0.0302	-0.0051	0.0067	0.0483	0.0150	0.0152	0.0303	-0.0052	0.0066

0 1 2 3 4 5



Test designation compliant with TR3, Chapter 4.6 Response during grid faults. Table 4-67			Two phase voltage drops in Positive phase sequence system											
			P			Q			Ia			Iq		
			MXE	ME	MAE	MXE	ME	MAE	MXE	ME	MAE	MXE	ME	MAE
0.20≤Ures≤0.30	In accordance with IEC	Pre	0.0096	0.0040	0.0040	0.0021	0.0009	0.0009	0.0201	0.0147	0.0147	0.0020	0.0008	0.0009
25.4		Fault	0.0039	-0.0030	0.0032	0.0071	0.0106	0.0058	0.0053	-0.0025	0.0042	0.0018	0.0077	0.0007
2ph/100%/2		Post	0.0101	-0.0041	0.0118	0.0402	-0.0084	0.0098	0.0216	0.0065	0.0225	0.0402	-0.0082	0.0099
0.20≤Ures≤0.30	In accordance with IEC	Pre	0.0029	-0.0021	0.0021	0.0004	0.0000	0.0001	0.0029	-0.0022	0.0022	0.0004	0.0000	0.0001
25.5		Fault	0.0042	0.0021	0.0029	0.0090	0.0118	0.0079	0.0066	0.0040	0.0046	0.0130	0.0179	0.0112
2ph/20%/2		Post	0.0135	0.0027	0.0033	0.0382	-0.0083	0.0086	0.0133	0.0027	0.0032	0.0382	-0.0080	0.0088
0.45≤Ures≤0.60	In accordance with IEC	Pre	0.0279	-0.0217	0.0217	0.0019	-0.0005	0.0006	0.0197	-0.0136	0.0136	0.0020	-0.0006	0.0007
50.3		Fault	0.0084	0.0034	0.0060	0.0277	-0.0229	0.0253	0.0116	0.0052	0.0084	0.0330	-0.0263	0.0294
2ph/100%/2		Post	0.0260	-0.0251	0.0251	0.0384	-0.0085	0.0088	0.0162	-0.0166	0.0167	0.0384	-0.0083	0.0090
0.45≤Ures≤0.60	In accordance with IEC	Pre	0.0026	-0.0020	0.0020	0.0004	-0.0000	0.0001	0.0027	-0.0021	0.0021	0.0004	-0.0000	0.0001
50.4		Fault	0.0077	0.0049	0.0053	0.0180	-0.0135	0.0154	0.0113	0.0077	0.0081	0.0129	-0.0069	0.0094
2ph/20%/2		Post	0.0161	0.0049	0.0053	0.0340	-0.0072	0.0075	0.0160	0.0049	0.0053	0.0339	-0.0070	0.0077
0.45≤Ures≤0.60	In accordance with IEC	Pre	0.0028	-0.0023	0.0023	0.0117	-0.0109	0.0109	0.0329	0.0322	0.0322	0.0119	-0.0112	0.0112
50.6		Fault	0.0103	-0.0118	0.0086	0.0047	-0.0004	0.0038	0.0154	-0.0163	0.0128	0.0071	-0.0004	0.0056
2ph/100%/2L		Post	0.0269	-0.0037	0.0133	0.0479	-0.0178	0.0179	0.0615	0.0300	0.0451	0.0481	-0.0180	0.0182
0.75≤Ures≤0.85	In accordance with IEC	Pre	0.0084	0.0036	0.0037	0.0023	0.0007	0.0008	0.0132	0.0084	0.0084	0.0022	0.0007	0.0008
75.6		Fault	0.0056	-0.0057	0.0031	0.0368	-0.0318	0.0335	0.0065	-0.0064	0.0034	0.0418	-0.0358	0.0377
3ph/100%/2		Post	0.0118	-0.0046	0.0118	0.0343	-0.0075	0.0088	0.0186	0.0009	0.0174	0.0342	-0.0075	0.0088
0.75≤Ures≤0.85	In accordance with IEC	Pre	0.0028	-0.0021	0.0021	0.0008	0.0004	0.0004	0.0019	-0.0012	0.0012	0.0007	0.0003	0.0003
75.7		Fault	0.0055	-0.0040	0.0035	0.0104	-0.0079	0.0092	0.0058	-0.0040	0.0034	0.0060	-0.0032	0.0046
2ph/20%/2		Post	0.0097	0.0040	0.0042	0.0318	-0.0071	0.0076	0.0106	0.0050	0.0052	0.0318	-0.0071	0.0076
0.75≤Ures≤0.85	In accordance with IEC	Pre	0.0007	0.0000	0.0002	0.0004	0.0001	0.0001	0.0014	0.0007	0.0007	0.0004	0.0001	0.0001
75.8		Fault	0.0066	-0.0051	0.0050	0.0416	-0.0374	0.0395	0.0073	-0.0057	0.0056	0.0445	-0.0398	0.0422
2ph≥10%/4		Post	0.0109	0.0069	0.0073	0.0305	-0.0075	0.0077	0.0116	0.0076	0.0080	0.0305	-0.0075	0.0078
0.85≤Ures≤0.90	In accordance with IEC	Pre	0.0213	0.0158	0.0158	0.0019	0.0007	0.0007	0.0212	0.0159	0.0159	0.0019	0.0007	0.0007
80.2		Fault	0.0843	-0.0772	0.0787	0.0080	0.0056	0.0058	0.0992	-0.0899	0.0914	0.0089	0.0062	0.0064
2ph/100%/0L		Post	0.0207	0.0153	0.0161	0.0023	0.0008	0.0009	0.0207	0.0155	0.0165	0.0023	0.0008	0.0009
Ures≥1.10	In accordance with IEC	Pre	0.0070	-0.0024	0.0026	0.0015	-0.0003	0.0005	0.0061	0.0015	0.0021	0.0015	-0.0003	0.0005
110.1		Fault	0.0098	-0.0048	0.0040	0.0271	-0.0230	0.0228	0.0055	-0.0009	0.0012	0.0254	-0.0218	0.0215
2ph/100%/2		Post	0.0079	-0.0055	0.0057	0.0334	-0.0061	0.0066	0.0074	-0.0016	0.0062	0.0334	-0.0061	0.0066
Ures≥1.10	In accordance with IEC	Pre	0.0038	-0.0008	0.0008	0.0008	0.0003	0.0003	0.0029	0.0001	0.0005	0.0007	0.0002	0.0002
110.2		Fault	0.0165	-0.0084	0.0087	0.0203	-0.0183	0.0179	0.0144	-0.0071	0.0073	0.0192	-0.0174	0.0170
2ph/20%/2		Post	0.0105	-0.0009	0.0011	0.0302	-0.0054	0.0063	0.0096	0.0000	0.0008	0.0303	-0.0054	0.0063

Test designation compliant with TR3, Chapter 4.6 Response during grid faults. Table 4-67			Two phase voltage drops in Negative phase sequence system											
			P			Q			Ia			Iq		
			MXE	ME	MAE	MXE	ME	MAE	MXE	ME	MAE	MXE	ME	MAE
0.20≤Ures≤0.30 25.4 2ph/100%/2	In accordance with IEC	Pre	0.0000	0.0000	0.0000	0.0000	0.0000	0.0000	0.0017	0.0005	0.0006	0.0022	0.0008	0.0008
		Fault	0.0016	-0.0016	0.0007	0.0170	-0.0189	0.0165	0.0042	-0.0038	0.0018	0.0402	-0.0452	0.0390
		Post	0.0000	-0.0000	0.0001	0.0000	-0.0004	0.0004	0.0102	0.0010	0.0017	0.0068	0.0003	0.0016
0.20≤Ures≤0.30 25.5 2ph/20%/2	In accordance with IEC	Pre	0.0000	-0.0000	0.0000	0.0000	0.0000	0.0000	0.0012	-0.0006	0.0006	0.0013	0.0006	0.0006
		Fault	0.0014	-0.0012	0.0007	0.0099	-0.0117	0.0092	0.0039	-0.0031	0.0019	0.0295	-0.0335	0.0276
		Post	0.0000	-0.0000	0.0001	0.0000	-0.0004	0.0004	0.0038	-0.0003	0.0012	0.0040	0.0004	0.0014
0.45≤Ures≤0.60 50.3 2ph/100%/2	In accordance with IEC	Pre	0.0000	0.0000	0.0000	0.0000	0.0000	0.0000	0.0019	0.0006	0.0007	0.0029	0.0008	0.0008
		Fault	0.0031	0.0025	0.0026	0.0055	0.0044	0.0051	0.0126	0.0099	0.0104	0.0233	0.0193	0.0217
		Post	0.0000	-0.0000	0.0000	0.0000	-0.0002	0.0002	0.0084	0.0007	0.0013	0.0073	0.0002	0.0014
0.45≤Ures≤0.60 50.4 2ph/20%/2	In accordance with IEC	Pre	0.0000	-0.0000	0.0000	0.0000	0.0000	0.0000	0.0011	-0.0006	0.0006	0.0014	0.0007	0.0007
		Fault	0.0032	0.0025	0.0027	0.0091	0.0074	0.0080	0.0128	0.0103	0.0106	0.0321	0.0251	0.0274
		Post	0.0000	-0.0000	0.0000	0.0000	-0.0002	0.0002	0.0047	-0.0003	0.0010	0.0051	0.0006	0.0016
0.45≤Ures≤0.60 50.6 2ph/100%/2L	In accordance with IEC	Pre	0.0000	0.0000	0.0000	0.0000	0.0000	0.0000	0.0048	0.0039	0.0039	0.0042	0.0032	0.0032
		Fault	0.0011	0.0007	0.0007	0.0010	-0.0002	0.0007	0.0065	0.0046	0.0043	0.0060	-0.0009	0.0044
		Post	0.0000	0.0000	0.0000	0.0000	0.0000	0.0000	0.0096	0.0036	0.0039	0.0095	0.0033	0.0034
0.75≤Ures≤0.85 75.6 3ph/100%/2	In accordance with IEC	Pre	0.0000	0.0000	0.0000	0.0000	0.0000	0.0000	0.0018	0.0004	0.0005	0.0024	0.0009	0.0009
		Fault	0.0014	0.0010	0.0010	0.0019	0.0012	0.0014	0.0115	0.0080	0.0080	0.0134	0.0086	0.0096
		Post	0.0000	-0.0000	0.0000	0.0000	0.0000	0.0000	0.0060	0.0004	0.0011	0.0064	0.0009	0.0013
0.75≤Ures≤0.85 75.7 2ph/20%/2	In accordance with IEC	Pre	0.0000	-0.0000	0.0000	0.0000	0.0000	0.0000	0.0014	-0.0007	0.0007	0.0013	0.0006	0.0006
		Fault	0.0015	0.0009	0.0009	0.0032	0.0024	0.0026	0.0117	0.0075	0.0074	0.0188	0.0138	0.0147
		Post	0.0000	-0.0000	0.0000	0.0000	0.0000	0.0000	0.0041	-0.0005	0.0009	0.0053	0.0009	0.0013
0.75≤Ures≤0.85 75.8 2ph≥10%/4	In accordance with IEC	Pre	0.0000	-0.0000	0.0000	0.0000	0.0000	0.0000	0.0013	-0.0008	0.0008	0.0011	0.0006	0.0006
		Fault	0.0020	0.0016	0.0016	0.0044	0.0037	0.0040	0.0163	0.0130	0.0132	0.0261	0.0215	0.0233
		Post	0.0000	-0.0000	0.0000	0.0000	-0.0000	0.0001	0.0032	-0.0006	0.0012	0.0049	0.0010	0.0017
0.85≤Ures≤0.90 80.2 2ph/100%/0L	In accordance with IEC	Pre	0.0000	0.0000	0.0000	0.0000	0.0000	0.0000	0.0026	0.0006	0.0007	0.0025	0.0008	0.0008
		Fault	0.0005	0.0001	0.0001	0.0003	-0.0002	0.0002	0.0053	0.0015	0.0012	0.0031	-0.0017	0.0017
		Post	0.0000	-0.0000	0.0000	0.0000	0.0000	0.0000	0.0019	0.0002	0.0006	0.0025	0.0010	0.0011
Ures≥1.10 110.1 2ph/100%/2	In accordance with IEC	Pre	0.0000	0.0000	0.0000	0.0000	0.0000	0.0000	0.0021	0.0002	0.0006	0.0027	0.0011	0.0012
		Fault	0.0033	-0.0028	0.0028	0.0007	-0.0004	0.0004	0.0061	-0.0001	0.0011	0.1354	0.1306	0.1316
		Post	0.0000	-0.0000	0.0000	0.0000	-0.0000	0.0000	0.0050	0.0004	0.0010	0.0072	0.0010	0.0018
Ures≥1.10 110.2 2ph/20%/2	In accordance with IEC	Pre	0.0000	0.0000	0.0000	0.0000	0.0000	0.0000	0.0013	0.0002	0.0003	0.0009	0.0001	0.0002
		Fault	0.0006	-0.0002	0.0002	0.0015	-0.0011	0.0011	0.0068	-0.0021	0.0021	0.0174	-0.0139	0.0136
		Post	0.0000	-0.0000	0.0000	0.0000	-0.0000	0.0000	0.0090	-0.0000	0.0006	0.0094	0.0000	0.0007

3.1.2 Simulation results of Voltage-Dependent PQ diagrams of certified models

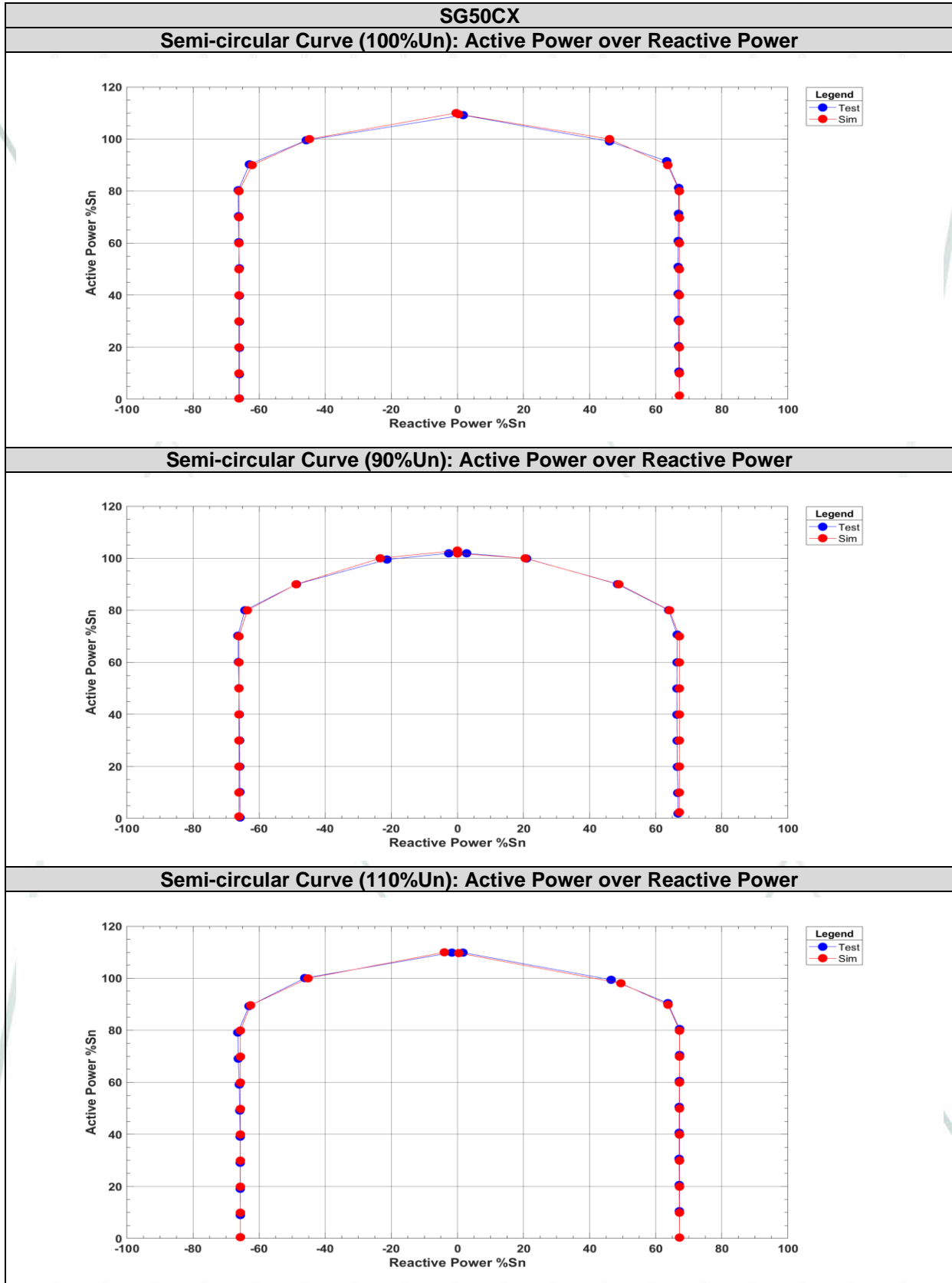

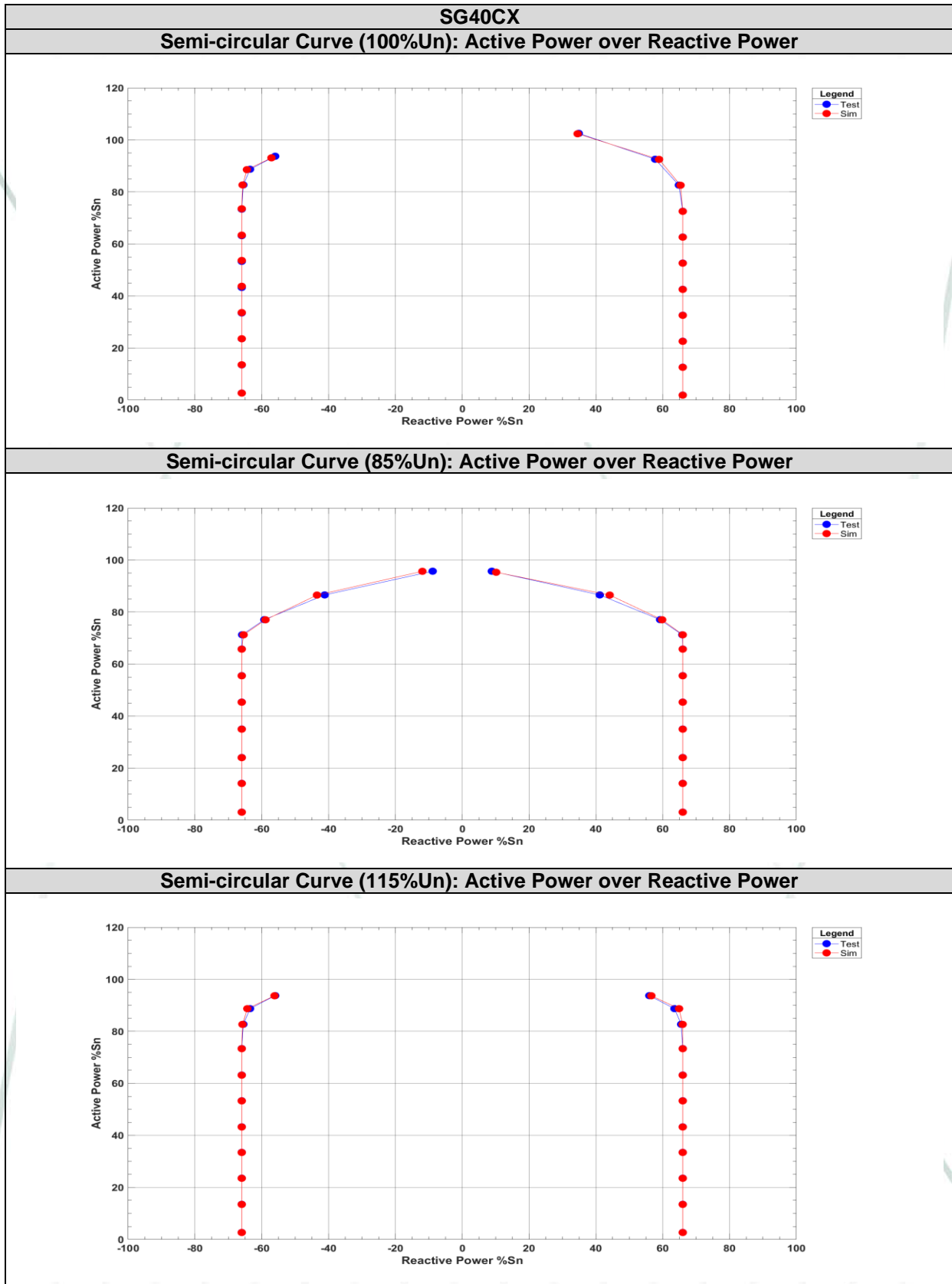

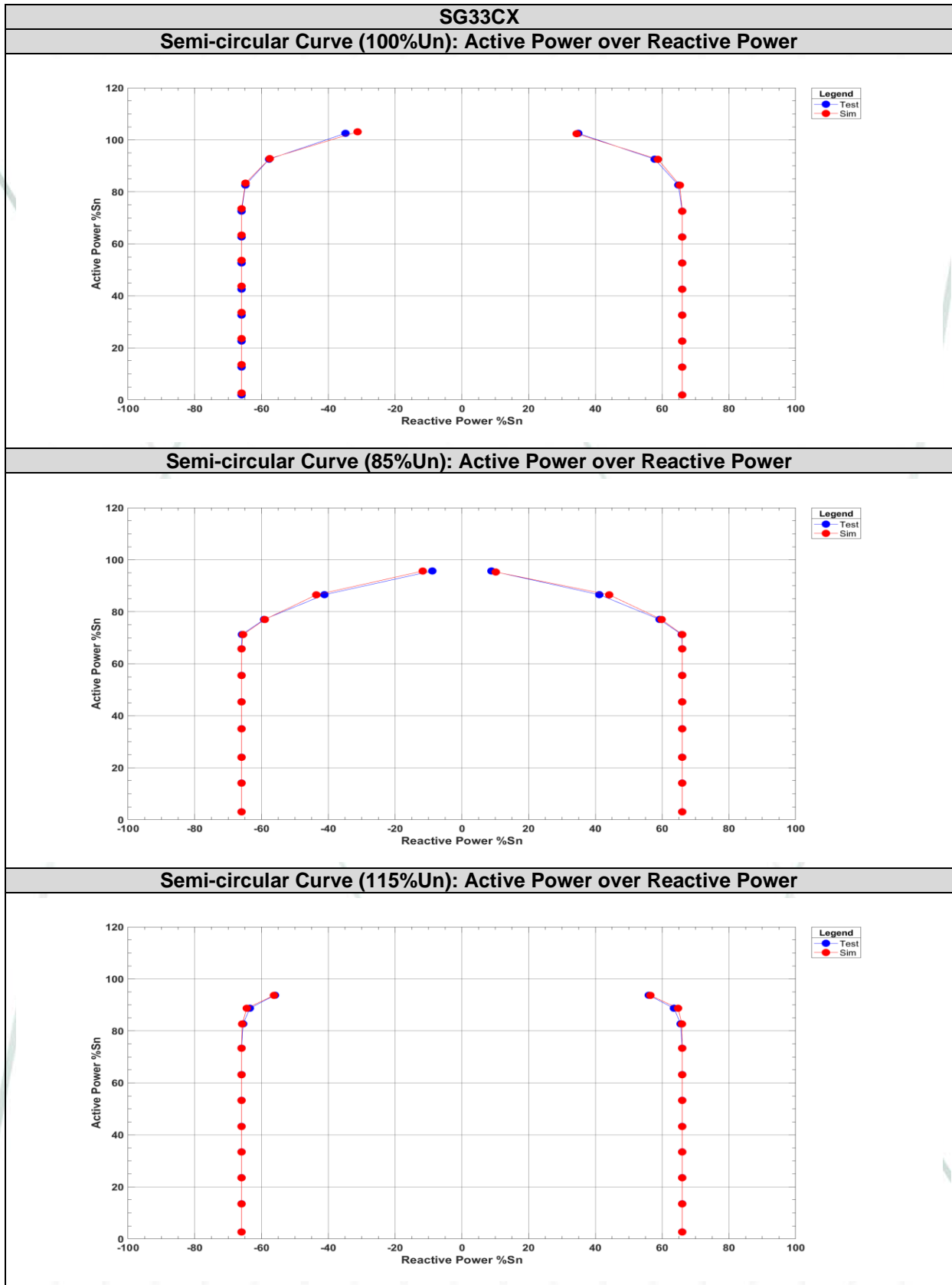

3.1.3 Additional tests

The following tests were performed to demonstrate that the updated Dynamic Simulation Model (version 3.2) does not show any critical change compared to the previous version used in the original report number 2221/0015-E1-TG4

- Simulation cases 0.1, 0.2, 0.3, 0.4, 50.6, 75.3, 75.4, 75.5, 75.8 and 80.2

The results are shown in the report no. 2221/0015-E1/A-TG4.

In addition, the manufacturer provides a statement that the updated Dynamic Simulation Model (version 3.2) does not result in any critical change to the previous version model.

Compromise letter

We **SUNGROW POWER SUPPLY CO., LTD.**

Declare that
The only change shown in the model (SG50CX/SG40CX/SG33CX) is:

The negative sequence angle input is added to the model, so the power flow model setting needs to start the negative sequence angle. to start the negative sequence angle, as shown in the figure below.

and the rest of the functions between version (V3.1) and version (V3.2) remain the same.

Date: Jan.19th, 2022

Name: Huang Jie
Charge: Standard and Certification Engineer
Signature: *Huang Jie*
Company Seal:

3.2 Validation conclusion

Once evaluated the entire tests required to carry out the comparison between simulation and real tests, it is demonstrated that the behaviours of the electronic equipment and its dynamic simulation model **FULLY COMPLIES (*)** with validation requirements according to the specifications of the standard:

- FGW Technical Guidelines for Power Generating Units. Part 4 - Revision 9, dated on 01/02/2019 (FGW TG4 Rev.9): Demands on Modelling and Validating Simulation Models of the Electrical Characteristics of Power Generating Units and Systems, Storage Systems as well as their Components.

Using as reference following standards:

- VDE-AR-N 4110: 2018-11. Technical requirements for the connection and operation of customer installations to the medium voltage network (TAR medium voltage).

The Dynamic Simulation Model can be considered as validated to simulate with the required accuracy test cases over PV inverter models SG50CX, SG40CX and SG33CX.

(*) Simulation results offered in this validation report were obtained with the Powerfactory Digsilent 2020 SP1B 20.0.3_A_2. This validation report doesn't cover upper version of Digsilent above 2020 SP1B 20.0.3_A_2.

4 TECHNICAL DATA

4.1 Technical data

Model	SG50CX	SG40CX	SG33CX
PV String Input Data			
Max. DC voltage	1100 V		
MPPT voltage range	200~1000 V		
Full power MPPT voltage range	550~850 V	550~850 V	550~850 V
Nominal DC voltage	580 V		
No. of MPP trackers	5	4	3
No. of strings per MPP tracker	2	2	2
Max. input current	5*26 A	4*26 A	3*26 A
Max. short current	5*40 A	4*40 A	3*40 A
AC Output Data			
Nominal grid voltage	3/N/PE, 230/400 Vac		
Nominal grid frequency	50 Hz		
Rated AC power	50 kW	40 kW	33 kW
Max. AC power	55 kVA	44 kVA	36.3 kVA
Rated AC current (*)	72.5 A	58.0 A	47.83 A
Max. AC current	83.6 A	66.9 A	55.2 A
Output power factor	>0.99 (0.8 leading to 0.8 lagging)		
Feature			
Operating temperature range	-30°C~60°C		
Protection degree	IP66		
Protective class	Class I		
Cooling method	Smart forced air cooling		

4.2 Overview of important parameters of the generation unit

The settings may be specific for each project and needed to be checked.

Parameter description	Unit	Default Value	Min.	Max.	Step- wide	Note
Behaviour in the event of disturbances in the network						
LVRT Protection Level		Fourth level				First Level / Second Level / Third Level / Fourth Level / Fifth Level
LVRT Voltage 1	V	207.0	0.0	230.0	0.1 V	
LVRT Time 1	ms	3600000	40	14400000	1 ms	
LVRT Voltage 2	V.	195.5	0.0	230.0	0.1 V	
LVRT Time 2	ms	3600000	40	14400000	1 ms	
LVRT Voltage 3	V	161.0	0.0	230.0	0.1 V	
LVRT Time 3	ms	5000	40	14400000	1 ms	
LVRT Voltage 4	V	34.5	0.0	230.0	0.1 V	
LVRT Time 4	ms	150	40	14400000	1 ms	
LVRT Exit		ON				ON / OFF
LVRT Exit Time	s	5	0	100	1s	
LVRT K Factor		2.0	0	10.0	0.1	VDE-AR-N 4110: 2018
HVRT Protection						
HVRT Protection Level		Third Level				First Level / Second Level / Third Level / Fourth Level / Fifth Level
HVRT Voltage 1	V	253.0	230.0	322.0	0.1 V	
HVRT Time 1	ms	1800000	40	14400000	1 ms	
HVRT Voltage 2	V.	276.0	230.0	322.0	0.1 V	
HVRT Time 2	ms	1800000	40	14400000	1 ms	
HVRT Voltage 3	V	287.5	230.0	322.0	0.1 V	
HVRT Time 3	ms	100	40	14400000	1 ms	
Zero Power mode		OFF				ON / OFF
HVRT Exit		ON				ON / OFF
HVRT Exit Time	s	5	0	100	1s	
Gradient for active power increase after fault recovery	%Pn/s	39	--	--	--	Pn: Rated active power. Just after LVRT drops
Others						
Islanding judge criteria (When select 'Frequency change protection')	--	Close				Close / Frequency change / Phase Change / Frequency and phase changes
Frequency change	Hz/s	2.000	0.100	10.000	0.001 Hz/s	
Protection time	s	0.50	0.12	300.00	--	
Active speed control (When select 'Active power adjustment')	--	ON	--	--	--	ON / OFF
Limited power switch	--	ON	--	--	--	ON / OFF
Pac limit	%Pn	110.0	0.0	110.0	--	

Parameter description	Unit	Default Value	Min.	Max.	Step- wide	Note
Active power by setpoint						
Power Limiting switch		ON				ON / OFF
Pac Limit	%Pn	110	0	110.0	0.1	Pn: Rated active power
Active speed control		ON				ON / OFF
Active Power Decline Speed	%Pn/min	39	1	6000	1%Pn/min	Power decrease
Active Power Rising Speed	%Pn/min	39	1	6000	1%Pn/min	Power increase
Description of interfaces	--	--	--	--	--	RS485 Interface
Behaviour at P=0	--	--	--	--	--	The inverter stays connected to grid. working at P<0.5%Pn the inverter goes to standby mode
Active power reduction at overfrequency						
Over frequency derating	--	ON	--	--	--	ON / OFF
Gradient	%Pref/Hz	40.00	16.67	100.00	--	
F1	Hz	50.20	50.02	55.00	0.01	
P1	%Pn	100.0	0.0	100.0	0.1	
F2	Hz	52.50	50.02	55.00	0.01	
P2	%Pn	8.0	0.0	100.0	0.1	
F3	Hz	52.50	50.02	55.00	0.01	
P3	%Pn	0.0	0.0	100.0	0.1	
Active power drop rate in overfrequency drop	%Pn/min	6000	1	6000	--	
Active power restoration rate after overfrequency drop	%Pn/min	9	1	6000	--	
Overfrequency drop curve	--	A curve	--	--	--	A curve / B curve

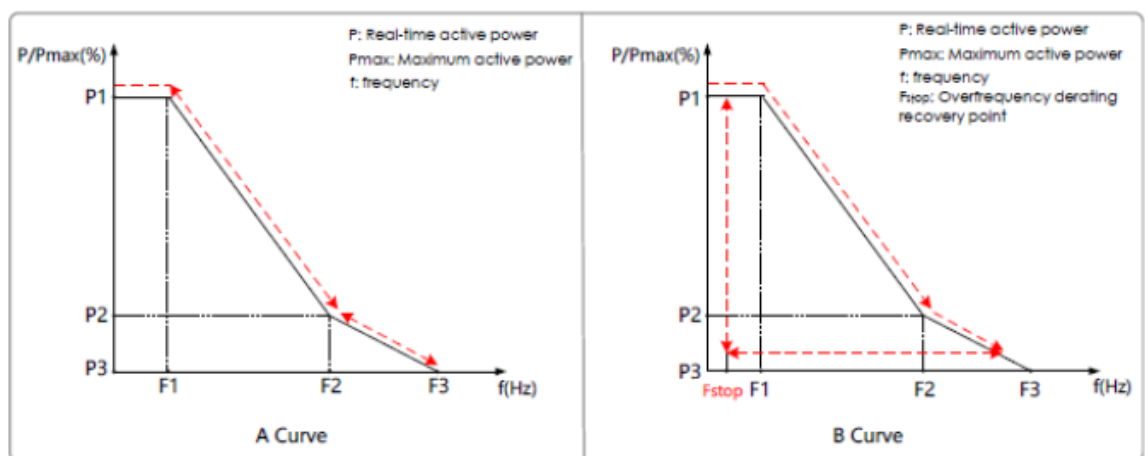

Power reduction at Overfrequency

Parameter description	Unit	Default Value	Min.	Max.	Step- wide	Note
Active power injection at underfrequency						
Underfrequency increment	--	ON	--	--	--	ON / OFF
Gradient	%Pref/Hz	40.00	16.67	100.00	--	The gradient is not a separate parameter. The gradient results from the setting values of parameters F1 to F4 and P1 to P4. With the specified setting values for P1 to P4 and F1 to F4 the required setting range for the gradient (16.67 % Pref / Hz to 100 % Pref / Hz) is fulfilled.
F1	Hz	49.80	45.00	49.98	0.01	
P1	%Pn	0.0	0.0	100.0	0.1	
F2	Hz	49.80	45.00	49.98	0.01	
P2	%Pn	0.0	0.0	100.0	0.1	
F3	Hz	47.50	45.00	49.98	0.01	
P3	%Pn	92	0.0	100.0	0.1	
Active power drop rate in overfrequency drop	%Pn/min	6000	1	6000	--	
Active power restoration rate after overfrequency drop	%Pn/min	9	1	6000	--	
Underfrequency drop curve	--	A curve	--	--	--	A curve / B curve

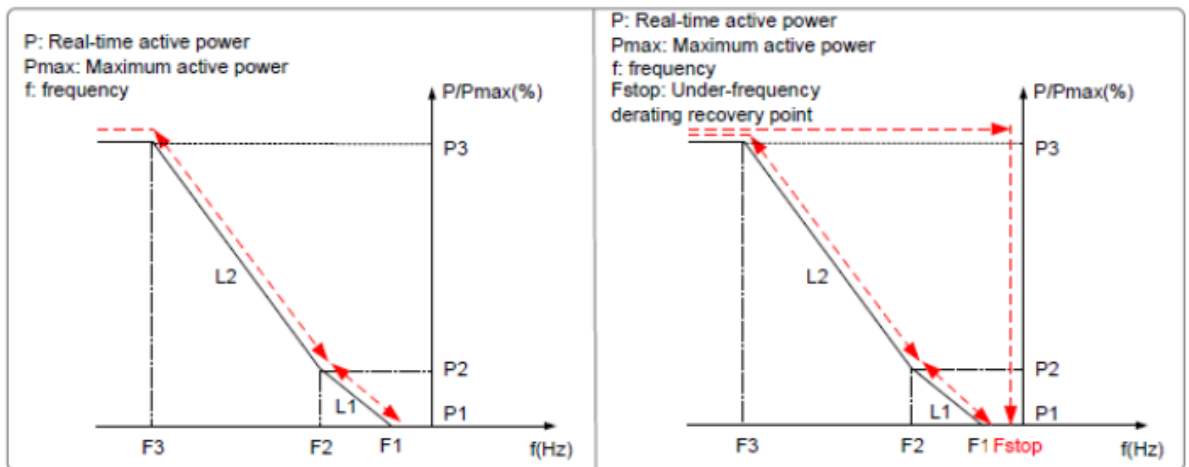

Power increment at underfrequency

Parameter description	Unit	Default Value	Min.	Max.	Step- wide	Note
Reactive power supply						
Reactive power regulation mode (when select 'Reactive adjusting switch')	--	Off	--	--	--	Off / Pf / Qt / Q(P) / Q(U) (Off: The PF is limited to +1.000. and the 'Reactive power limit' is limited to 0.0%)
Reactive power supply. Mode PF: The reactive power can be regulated by the parameter PF (Power Factor).						
PF (when select Pf).	--	1.000	-1.000 ~ -0.800	+1.000 ~ +0.800	0.001	

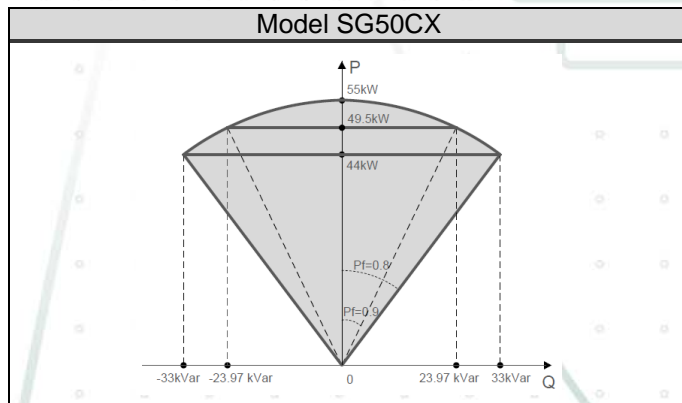
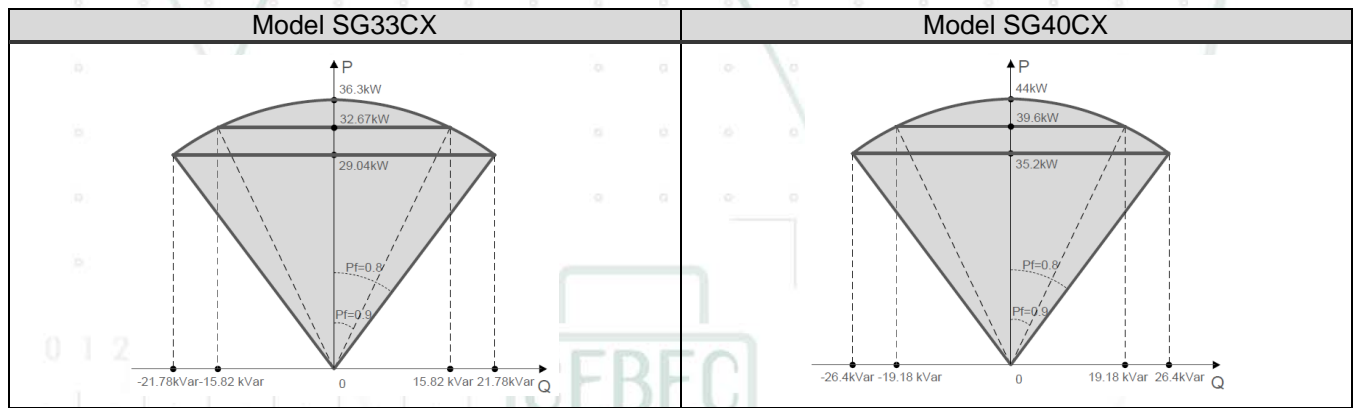

Reactive power supply. Mode Qt: The reactive power can be regulated by the parameter 'Reactive power limit' (in %).

Reactive power limit (when select Qt).	%	0.0	-100.0	+100.0	0.1	
--	---	-----	--------	--------	-----	--

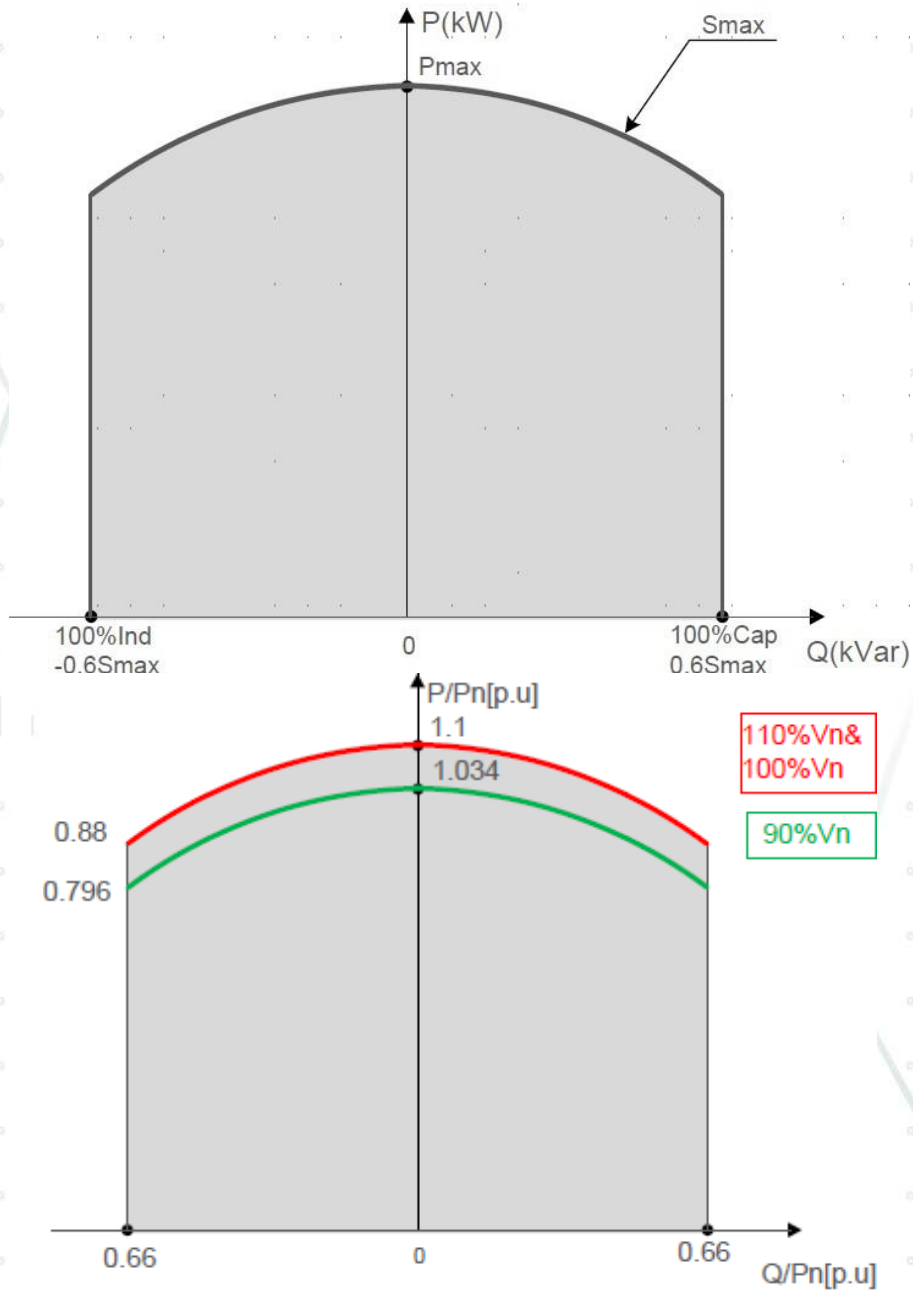
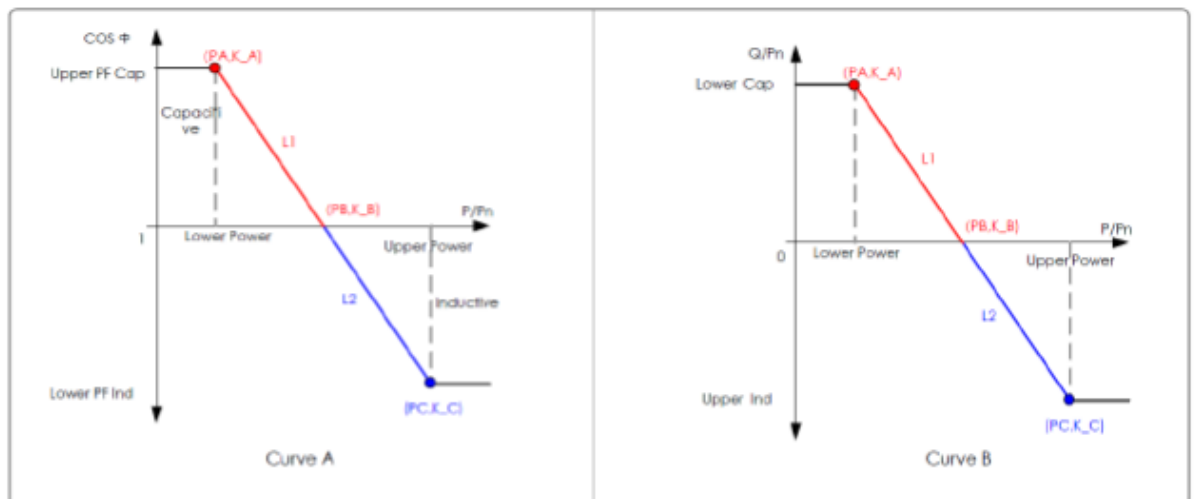
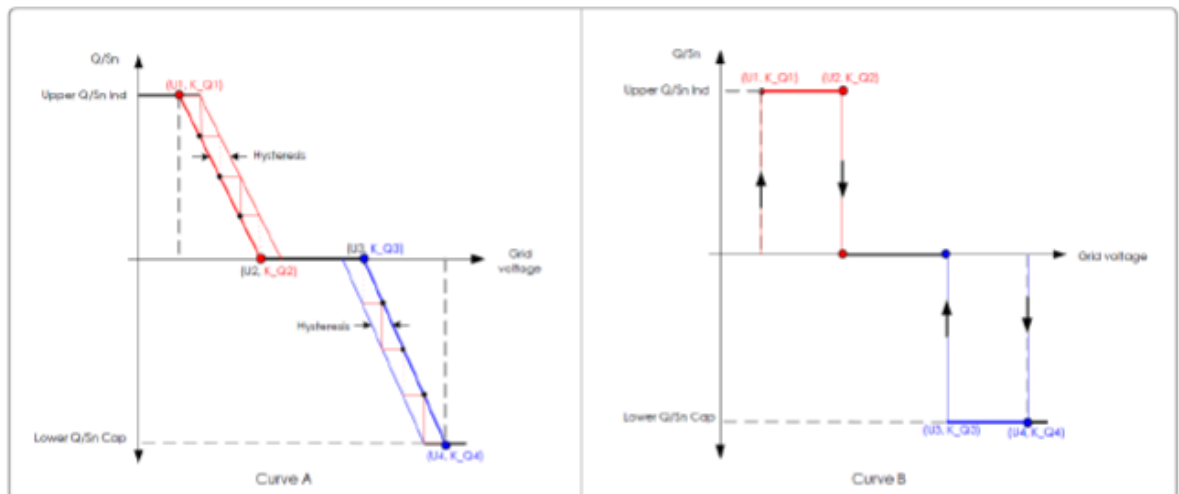

Figure 4a Voltage-dependent PQ diagram for SG50CX/SG33CX/ SG40CX

Reactive power supply. Mode Q(P): The reactive ratio or power factor changes with the output power of the inverter.						
Q(P) Curve (when select Q(P))	--	B curve	--	--	--	A curve / B curve / C curve (A curve set for power factor; B curve set for reactive ratio)
Active power ratio PA	%	50.0	10.0	100.0	0.1	
Active power ratio PB	%	60.0	20.0	100.0	0.1	
Active power ratio PC	%	90.0	20.0	100.0	0.1	
Corresponding reactive ratio or power factor of active power ratio PA point	p.u.	0.000	-0.66	+0.66	0.001	
Corresponding reactive ratio or power factor of active power ratio PB point	p.u.	0.050	-0.66	+0.66	0.001	
Corresponding reactive ratio or power factor of active power ratio PC point	p.u.	0.330	-0.66	+0.66	0.001	



Parameter description	Unit	Default Value	Min.	Max.	Step- wide	Note
Reactive power supply. Mode Q(U): The reactive power changes with the grid voltage.						
Q(U) curve	A curve					A curve / B curve / C curve (A curve set for reactive power with voltage limiting function); B curve set for reactive power voltage characteristic Q(U))
Hysteretic proportion	%	0.0	0.0	5.0	0.1	
Voltage proportion U1	%	94.0	80.0	100.0	0.1	B curve: 96.0%
Voltage proportion U2	%	96.0	80.0	100.0	0.1	B curve: 100.0%
Voltage proportion U3	%	104.0	100.0	120.0	0.1	B curve: 100.0%
Voltage proportion U4	%	106.0	100.0	120.0	0.1	B curve: 104.0%
Corresponding reactive ratio of voltage proportion U1	%	-33.0	-66.0	0.0	0.1	
Corresponding reactive ratio of voltage proportion U2	%	0.0	-66.0	+66.0	0.1	
Corresponding reactive ratio of voltage proportion U3	%	0.0	-66.0	+66.0	0.1	
Corresponding reactive ratio of voltage proportion U4	%	+33.0	0.0	+66.0	0.1	
Reactive response	--	ON	--	--	--	ON / OFF
Reactive response time	s	6.0	0.1	60.0	0.1	



Parameter description	Unit	Default Value	Min.	Max.	Step- wide	Note
Limits for re-energizing (reconnection after fault event)						
Undervoltage Protection Recovery Value	V	218.5	23.0	230.0	0.1	
Overvoltage Protection Recovery Value	V	251.0	230.1	321.9	0.1	
Underfrequency Protection Recovery Value	Hz	49.90	45.02	49.98	0.01	
Overfrequency Protection Recovery Value	Hz	50.10	50.02	54.98	0.01	
Fault Recovery Time	s	600	0	3600	1	
Fault Recovery Active Soft Start		ON				ON / OFF
Fault Recovery Active Soft Start Time	s	600	1	1200	1	Takes 222s from 0%Pn to 100%Pn
Limits for connection (without previous trip)						
Grid Connection Condition		ON	--	--	--	ON/OFF
Grid Connection Voltage Minimum	p.u.[%]	90.0%	50.0%	100.0%	0.1%	
Max. Grid-connected Voltage	p.u.[%]	110.0%	100.0%	120.0%	0.1%	
Grid Connection Frequency Minimum	Hz	47.50	47.00	49.98	0.01	
Max. Grid-connected Frequency	Hz	50.20	50.02	52.00	0.01	
Grid Connection Detection Time	s	60	10	900	1	
Grid-connected Active Power Rising Rate	% Pn /min	39	3	6000	1	Pn: Rated active power
Grid Connection Condition		ON	--	--	--	ON/OFF

Parameter description	Unit	Default Value	Min.	Max.	Step- wide	Note
Protective functions						
AC Over-voltage Level 1 Protection Value	%	125.0	100.0	130.0	0.1%	
AC Over-voltage Level 1 Protection time	ms	100	40	180000	1ms	
AC Over-voltage Level 2 Protection Value	%	125.0	100.0	130.0	0.1%	
AC Over-voltage Level 2 Protection time	ms	100	50	180000	1ms	
AC Under-voltage Level 1 Protection Value	%	80.0	10.0	100.0	0.1%	
AC Under-voltage Level 1 Protection Time	ms	1000	40	2400	1ms	
AC Under-voltage Level 2 Protection Value	%	45.0	10.0	100.0	0.1%	
AC Under-voltage Level 2 Protection Time	ms	300	100	900	1ms	
Grid Overfrequency Level 1 Protection Value	Hz	51.50	50.00	55.00	0.01 Hz	
Grid Overfrequency Level 1 Protection Time	s	5.00	0.04	5.00	0.01 s	
Grid Overfrequency Level 2 Protection Value	Hz	52.50	50.00	55.00	0.01 Hz	
Grid Overfrequency Level 2 Protection Time	s	0.10	0.04	5.00	0.01 s	
AC Under-frequency Level 1 Protection Value	Hz	47.50	45.00	50.00	0.01 Hz	
AC Under-frequency Level 1 Protection Time	s	0.10	0.04	0.10	0.01 s	
Evaluation of conductor-conductor or conductor-earth voltage						Every conductor-earth voltage
Logical AND or OR link						OR
Self-protection overvoltage (transient)			140% of the rated voltage and 1 ms			

4.3 Electric scheme

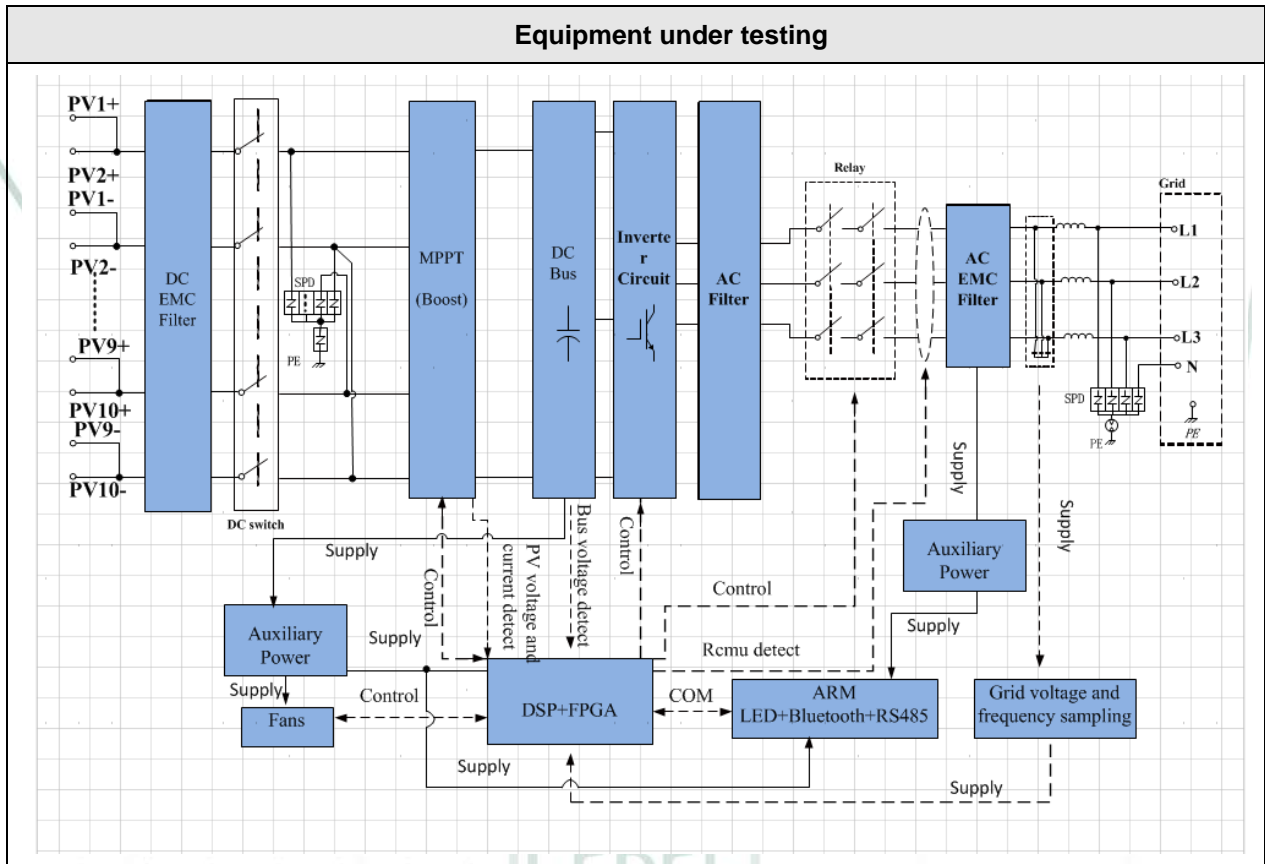

4.4 Interfaces

Following interfaces for setting parameters (include the active power or reactive power) configurations are provided on the PGU level:

- **Built-in Bluetooth module:** Firstly, the DC or AC power supply is on and the inverter LED indicator is in red or blue (according to the following description). The iSolarCloud App on your phone can establish communication connection to the inverter via the Bluetooth, thereby achieving near-end maintenance on the inverter. Users who has been authorized can use the App to set parameters (include active power and reactive power configurations), etc.

LED indicator	LED state	Definition
Blue	ON	The device is connected to the grid and operating normally.
	Fast blink (Period: 0.2s)	The Bluetooth communication is connected and there is data communication. No system fault occurs.
	Slow flash (Period: 2s)	The device is in standby or startup state (not feeding power into the grid).
Red	ON	A fault occurs and the device cannot connect to the grid
	Twinkling	The Bluetooth communication is connected and there is data communication. System fault occurs.
OFF	OFF	Both the AC and DC sides are powered down.

- **PLC communication or RS 485 communication:** The inverter is designed with standard RS485 communication interfaces and built-in PLC communication module. The standard RS485 communication interfaces or built-in PLC communication module are used to establish communication connection with monitoring devices (generally use Sungrow Logger 3000 or COM100 and PPC) and upload monitoring data . After communication connection is established, users who has been authorized can set inverter parameters (include active power and reactive power configurations) through the SunAccess or PPC website. For more details please refer to the PV inverter user manual.

Set inverter parameters from which way above is not much of difference on the setting point accuracy, setting/response time and always get a millisecond level or second level .

Further information of Switching-in conditions and control interface using a Power Plant Controller

In the case that switching in control is managed by a PPC, it is possible to connect or disconnect the inverter by means of a dry contact.

The configuration circuit board is provided with fault output dry contact and emergency stop dry contact, as shown in the figure below. Connection method of the dry contacts is like that of the RS485 terminal block.

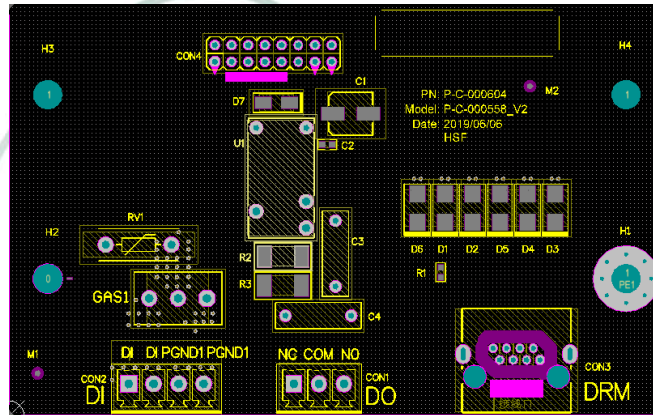

DI terminal (emergency stop dry contact): the dry contact can be configured to be a stop contact. When the DI contact and GND contact are shorted by external controlled switch, the inverter will immediately stop.

The following figure shows the typical application of local stop dry contact.

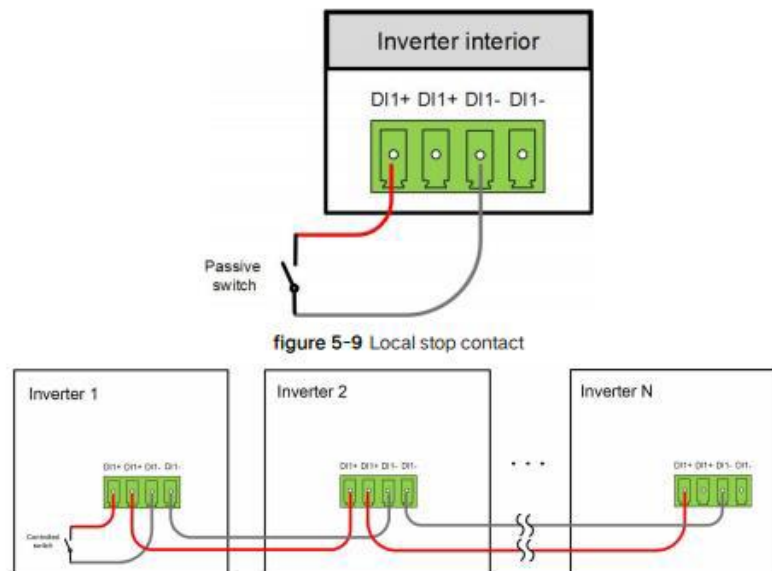

When wiring DI dry contacts, ensure that the maximum wiring distance meet the requirements as stated in the user manual.

The correct configuration of the Dry contact function is responsibility of the Powerplant controller designer, or the designer of the plant level protection concept and it is not of the interest of this certification, the information provided is only informative.

4.5 Manufacturer's certificates for certified PGUs according to FGW TG3

Manufacturer Certificate according to FGW TG3		
Herstellerbescheinigung zu spezifischen Daten eines Photovoltaik-Wechselrichters vom Typ SG50CX/SG40CX/SG33CX		
Manufacturer's certificate on specific data of a Photovoltaic Converter of the type SG50CX/SG40CX/SG33CX		
Datum / Date: 12/1/2021		Seite/Page 1/1
1	Allgemeines und Ausgangsgrößen	General and Output values
1	Hersteller	Sungrow Power Supply Co.,Ltd. manufacturer
2	Typenbezeichnung	SG50CX /SG40CX/SG33CX type name
3	Einspeisung (einphasig/dreiphasig)	three phase no. of phases (single-phase/three-phase)
4	Nennscheinleistung	50/40/33 (Max.55/44/36.3)kVA rated apparent power
5	Nennwirkleistung	50/40/33 kW rated active power
6	AC-Nennspannung	230/400 V rated AC-voltage
7	AC-Nennfrequenz	50 Hz rated frequency
8	Beitrag zum Stoßkurzschlussstrom	0.15/0.12/0.1 kA contribution to short circuit current
2	DC Eingangsgrößen	DC Input
1	Min. MPP-Spannung	200 V min. MPP voltage
2	Max. MPP-Spannung	1000 V max. MPP voltage
3	Max. PV-Eingangsspannung	1100 V max. DC input voltage
4	Max. PV-Eingangsstrom	130/104/78 A max. DC input current
5	Max. Modulleistung	55.7/44.6/34.0 kW _p max. peak power
3	Wechselrichter-Leistungsteil	Converter-Power section
1	Hersteller	Sungrow Power Supply Co.,Ltd. manufacturer
2	Typenbezeichnung	SG50CX /SG40CX/SG33CX type name
3	Nennscheinleistung	50/40/33 (Max.55/44/36.3)kVA rated apparent power
4	Art (HF/NF-Trafo, trafolos)	Without generic type (HV/LV of Trans., without)
5	Taktfrequenz	16.0 kHz pulse rate of inverter
6	Art der Leistungsregelung (MPP-Tracking)	MPP-Tracking generic type of power control (MPP-Tracking)
7	Software-Version	LCD AGATE-S V11 V01 AMDSP AGATE-S V11 V01 A software version
4	Sonstige elektrische Komponenten	Other electric installations
1	Art der Netzkopplung	Grid-connected inverter generic type of interconnection
2	- Hersteller	Sungrow Power Supply Co.,Ltd. - manufacturer
3	- Typenbezeichnung	SG50CX SG40CX/SG33CX - type
4	Netzschutz integriert (Ja/Nein)	yes integrated grid protection (yes/no)
5	Netzschutzhersteller	Sungrow Power Supply Co.,Ltd. grid protection manufacturer
6	- Typenbezeichnung	SG50CX SG40CX/SG33CX - type
7	- Einstellbereiche	yes - adjustment ranges
8	Spannungssteigerungsschutz	230-299 V overvoltage protection
9	Spannungsrückgangsschutz	23-230 V undervoltage protection
10	Frequenzsteigerungsschutz	50-55 Hz overfrequency protection
11	Frequenzrückgangsschutz	45-50 Hz underfrequency protection
12	Typenbezeichnung der Abschalteneinheit	1122 1124 1126 1128 1130 1132 1134 1136 1138 1140 1142 1144 1146 1148 1150 1152 1154 1156 1158 1160 1162 1164 1166 1168 1170 1172 1174 1176 1178 1180 1182 1184 1186 1188 1190 1192 1194 1196 1198 1200 1202 1204 1206 1208 1210 1212 1214 1216 1218 1220 1222 1224 1226 1228 1230 1232 1234 1236 1238 1240 1242 1244 1246 1248 1250 1252 1254 1256 1258 1260 1262 1264 1266 1268 1270 1272 1274 1276 1278 1280 1282 1284 1286 1288 1290 1292 1294 1296 1298 1300 1302 1304 1306 1308 1310 1312 1314 1316 1318 1320 1322 1324 1326 1328 1330 1332 1334 1336 1338 1340 1342 1344 1346 1348 1350 1352 1354 1356 1358 1360 1362 1364 1366 1368 1370 1372 1374 1376 1378 1380 1382 1384 1386 1388 1390 1392 1394 1396 1398 1400 1402 1404 1406 1408 1410 1412 1414 1416 1418 1420 1422 1424 1426 1428 1430 1432 1434 1436 1438 1440 1442 1444 1446 1448 1450 1452 1454 1456 1458 1460 1462 1464 1466 1468 1470 1472 1474 1476 1478 1480 1482 1484 1486 1488 1490 1492 1494 1496 1498 1500 1502 1504 1506 1508 1510 1512 1514 1516 1518 1520 1522 1524 1526 1528 1530 1532 1534 1536 1538 1540 1542 1544 1546 1548 1550 1552 1554 1556 1558 1560 1562 1564 1566 1568 1570 1572 1574 1576 1578 1580 1582 1584 1586 1588 1590 1592 1594 1596 1598 1600 1602 1604 1606 1608 1610 1612 1614 1616 1618 1620 1622 1624 1626 1628 1630 1632 1634 1636 1638 1640 1642 1644 1646 1648 1650 1652 1654 1656 1658 1660 1662 1664 1666 1668 1670 1672 1674 1676 1678 1680 1682 1684 1686 1688 1690 1692 1694 1696 1698 1700 1702 1704 1706 1708 1710 1712 1714 1716 1718 1720 1722 1724 1726 1728 1730 1732 1734 1736 1738 1740 1742 1744 1746 1748 1750 1752 1754 1756 1758 1760 1762 1764 1766 1768 1770 1772 1774 1776 1778 1780 1782 1784 1786 1788 1790 1792 1794 1796 1798 1800 1802 1804 1806 1808 1810 1812 1814 1816 1818 1820 1822 1824 1826 1828 1830 1832 1834 1836 1838 1840 1842 1844 1846 1848 1850 1852 1854 1856 1858 1860 1862 1864 1866 1868 1870 1872 1874 1876 1878 1880 1882 1884 1886 1888 1890 1892 1894 1896 1898 1900 1902 1904 1906 1908 1910 1912 1914 1916 1918 1920 1922 1924 1926 1928 1930 1932 1934 1936 1938 1940 1942 1944 1946 1948 1950 1952 1954 1956 1958 1960 1962 1964 1966 1968 1970 1972 1974 1976 1978 1980 1982 1984 1986 1988 1990 1992 1994 1996 1998 2000 2002 2004 2006 2008 2010 2012 2014 2016 2018 2020 2022 2024 2026 2028 2030 2032 2034 2036 2038 2040 2042 2044 2046 2048 2050 2052 2054 2056 2058 2060 2062 2064 2066 2068 2070 2072 2074 2076 2078 2080 2082 2084 2086 2088 2090 2092 2094 2096 2098 2100 2102 2104 2106 2108 2110 2112 2114 2116 2118 2120 2122 2124 2126 2128 2130 2132 2134 2136 2138 2140 2142 2144 2146 2148 2150 2152 2154 2156 2158 2160 2162 2164 2166 2168 2170 2172 2174 2176 2178 2180 2182 2184 2186 2188 2190 2192 2194 2196 2198 2200 2202 2204 2206 2208 2210 2212 2214 2216 2218 2220 2222 2224 2226 2228 2230 2232 2234 2236 2238 2240 2242 2244 2246 2248 2250 2252 2254 2256 2258 2260 2262 2264 2266 2268 2270 2272 2274 2276 2278 2280 2282 2284 2286 2288 2290 2292 2294 2296 2298 2300 2302 2304 2306 2308 2310 2312 2314 2316 2318 2320 2322 2324 2326 2328 2330 2332 2334 2336 2338 2340 2342 2344 2346 2348 2350 2352 2354 2356 2358 2360 2362 2364 2366 2368 2370 2372 2374 2376 2378 2380 2382 2384 2386 2388 2390 2392 2394 2396 2398 2400 2402 2404 2406 2408 2410 2412 2414 2416 2418 2420 2422 2424 2426 2428 2430 2432 2434 2436 2438 2440 2442 2444 2446 2448 2450 2452 2454 2456 2458 2460 2462 2464 2466 2468 2470 2472 2474 2476 2478 2480 2482 2484 2486 2488 2490 2492 2494 2496 2498 2500 2502 2504 2506 2508 2510 2512 2514 2516 2518 2520 2522 2524 2526 2528 2530 2532 2534 2536 2538 2540 2542 2544 2546 2548 2550 2552 2554 2556 2558 2560 2562 2564 2566 2568 2570 2572 2574 2576 2578 2580 2582 2584 2586 2588 2590 2592 2594 2596 2598 2600 2602 2604 2606 2608 2610 2612 2614 2616 2618 2620 2622 2624 2626 2628 2630 2632 2634 2636 2638 2640 2642 2644 2646 2648 2650 2652 2654 2656 2658 2660 2662 2664 2666 2668 2670 2672 2674 2676 2678 2680 2682 2684 2686 2688 2690 2692 2694 2696 2698 2700 2702 2704 2706 2708 2710 2712 2714 2716 2718 2720 2722 2724 2726 2728 2730 2732 2734 2736 2738 2740 2742 2744 2746 2748 2750 2752 2754 2756 2758 2760 2762 2764 2766 2768 2770 2772 2774 2776 2778 2780 2782 2784 2786 2788 2790 2792 2794 2796 2798 2800 2802 2804 2806 2808 2810 2812 2814 2816 2818 2820 2822 2824 2826 2828 2830 2832 2834 2836 2838 2840 2842 2844 2846 2848 2850 2852 2854 2856 2858 2860 2862 2864 2866 2868 2870 2872 2874 2876 2878 2880 2882 2884 2886 2888 2890 2892 2894 2896 2898 2900 2902 2904 2906 2908 2910 2912 2914 2916 2918 2920 2922 2924 2926 2928 2930 2932 2934 2936 2938 2940 2942 2944 2946 2948 2950 2952 2954 2956 2958 2960 2962 2964 2966 2968 2970 2972 2974 2976 2978 2980 2982 2984 2986 2988 2990 2992 2994 2996 2998 3000 3002 3004 3006 3008 3010 3012 3014 3016 3018 3020 3022 3024 3026 3028 3030 3032 3034 3036 3038 3040 3042 3044 3046 3048 3050 3052 3054 3056 3058 3060 3062 3064 3066 3068 3070 3072 3074 3076 3078 3080 3082 3084 3086 3088 3090 3092 3094 3096 3098 3100 3102 3104 3106 3108 3110 3112 3114 3116 3118 3120 3122 3124 3126 3128 3130 3132 3134 3136 3138 3140 3142 3144 3146 3148 3150 3152 3154 3156 3158 3160 3162 3164 3166 3168 3170 3172 3174 3176 3178 3180 3182 3184 3186 3188 3190 3192 3194 3196 3198 3200 3202 3204 3206 3208 3210 3212 3214 3216 3218 3220 3222 3224 3226 3228 3230 3232 3234 3236 3238 3240 3242 3244 3246 3248 3250 3252 3254 3256 3258 3260 3262 3264 3266 3268 3270 3272 3274 3276 3278 3280 3282 3284 3286 3288 3290 3292 3294 3296 3298 3300 3302 3304 3306 3308 3310 3312 3314 3316 3318 3320 3322 3324 3326 3328 3330 3332 3334 3336 3338 3340 3342 3344 3346 3348 3350 3352 3354 3356 3358 3360 3362 3364 3366 3368 3370 3372 3374 3376 3378 3380 3382 3384 3386 3388 3390 3392 3394 3396 3398 3400 3402 3404 3406 3408 3410 3412 3414 3416 3418 3420 3422 3424 3426 3428 3430 3432 3434 3436 3438 3440 3442 3444 3446 3448 3450 3452 3454 3456 3458 3460 3462 3464 3466 3468 3470 3472 3474 3476 3478 3480 3482 3484 3486 3488 3490 3492 3494 3496 3498 3500 3502 3504 3506 3508 3510 3512 3514 3516 3518 3520 3522 3524 3526 3528 3530 3532 3534 3536 3538 3540 3542 3544 3546 3548 3550 3552 3554 3556 3558 3560 3562 3564 3566 3568 3570 3572 3574 3576 3578 3580 3582 3584 3586 3588 3590 3592 3594 3596 3598 3600 3602 3604 3606 3608 3610 3612 3614 3616 3618 3620 3622 3624 3626 3628 3630 3632 3634 3636 3638 3640 3642 3644 3646 3648 3650 3652 3654 3656 3658 3660 3662 3664 3666 3668 3670 3672 3674 3676 3678 3680 3682 3684 3686 3688 3690 3692 3694 3696 3698 3700 3702 3704 3706 3708 3710 3712 3714 3716 3718 3720 3722 3724 3726 3728 3730 3732 3734 3736 3738 3740 3742 3744 3746 3748 3750 3752 3754 3756 3758 3760 3762 3764 3766 3768 3770 3772 3774 3776 3778 3780 3782 3784 3786 3788 3790 3792 3794 3796 3798 3800 3802 3804 3806 3808 3810 3812 3814 3816 3818 3820 3822 3824 3826 3828 3830 3832 3834 3836 3838 3840 3842 3844 3846 3848 3850 3852 3854 3856 3858 3860 3862 3864 3866 3868 3870 3872 3874 3876 3878 3880 3882 3884 3886 3888 3890 3892 3894 3896 3898 3900 3902 3904 3906 3908 3910 3912 3914 3916 3918 3920 3922 3924 3926 3928 3930 3932 3934 3936 3938 3940 3942 3944 3946 3948 3950 3952 3954 3956 3958 3960 3962 3964 3966 3968 3970 3972 3974 3976 3978 3980 3982 3984 3986 3988 3990 3992 3994 3996 3998 4000 4002 4004 4006 4008 4010 4012 4014 4016 4018 4020 4022 4024 4026 4028 4030 4032 4034 4036 4038 4040 4042 4044 4046 4048 4050 4052 4054 4056 4058 4060 4062 4064 4066 4068 4070 4072 4074 4076 4078 4080 4082 4084 4086 4088 4090 4092 4094 4096 4098 4100 4102 4104 4106 4108 4110 4112 4114 4116 4118 4120 4122 4124 4126 4128 4130 4132 4134 4136 4138 4140 4142 4144 4146 4148 4150 4152 4154 4156 4158 4160 4162 4164 4166 4168 4170 4172 4174 4176 4178 4180 4182 4184 4186 4188 4190 4192 4194 4196 4198 4200 4202 4204 4206 4208 4210 4212 4214 4216 4218 4220 4222 4224 4226 4228 4230 4232 4234 4236 4238 4240 4242 4244 4246 4248 4250 4252 4254 4256 4258 4260 4262 4264 4266 4268 4270 4272 4274 4276 4278 4280 4282 4284 4286 4288 4290 4292 4294 4296 4298 4300 4302 4304 4306 4308 4310 4312 4314 4316 4318 4320 4322 4324 4326 4328 4330 4332 4334 4336 4338 4340 4342 4344 4346 4348 4350 4352 4354 4356 4358 4360 4362 4364 4366 4368 4370 4372 4374 4376 4378 4380 4382 4384 4386 4388 4390 4392 4394 4396 4398 4400 4402 4404 4406 4408 4410 4412 4414 4416 4418 4420 4422 4424 4426 4428 4430 4432 4434 4436 4438 4440 4442 4444 4446 4448 4450 4452 4454 4456 4458 4460 4462 4464 4466 4468 4470 4472 4474 4476 4478 4480 4482 4484 4486 4488 4490 4492 4494 4496 4498 4500 4502 4504 4506 4508 4510 4512 4514 4516 4518 4520 4522 4524 4526 4528 4530 4532 4534 4536 4538 4540 4542 4544 4546 4548 4550 4552 4554 4556 4558 4560 4562 4564 4566 4568 4570 4572 4574 4576 4578 4580 4582 4584 4586 4588 4590 4592 4594 4596 4598 4600 4602 4604 4606 4608 4610 4612 4614 4616 4618 4620 4622 4624 4626 4628 4630 4632 4634 4636 4638 4640 4642 4644 4646 4648 4650 4652 4654 4656 4658 4660 4662 4664 4666 4668 4670 4672 4674 4676 4678 4680 4682 4684 4686 4688 4690 4692 4694 4696 4698 4700 4702 4704 4706 4708 4710 4712 4714 4716 4718 4720 4722 4724 4726 4728 4730 4732 4734 4736 4738 4740 4742 4744 4746 4748 4750 4752 4754 4756 4758 4760 4762 4764 4766 4768 4770 4772 4774 4776 4778 4780 4782 4784 4786 4788 4790 4792 4794 4796 4798 4800 4802 4804 4806 4808 4810 4812 4814 4816 4818 4820 4822 4824 4826 4828 4830 4832 4834 4836 4838 4840 4842 4844 4846 4848 4850 4852 4854 4856 4858 4860 4862 4864 4866 4868 4870 4872 4874 4876 4878 4880 4882 4884 4886 4888 4890 4892 4894 4896 4898 4900 4902 4904 4906 4908 4910 4912 4914 4916 4918 4920 4922 4924 4926 4928 4930 4932 4934 4936 4938 4940 4942 4944 4946 4948 4950 4952 4954 4956 4958 4960 4962 4964 4966 4968 4970 4972 4974 4976 4978 4980 4982 4984 4986 4988 4990 4992 4994 4996 4998 5000 5002 5004 5006 5008 5010 5012 5014 5016 5018 5020 5022 5024 5026 5028 5030 5032 5034 5036 5038 5040 5042 5044 5046 5048 5050 5052 5054 5056 5058 5060 5062 5064 5066 5068 5070 5072 5074 5076 5078 5080 5082 5084 5086 5088 5090 5092 5094 5096 5098 5100 5102 5104 5106 5108 5110 5112 5114 51

4.6 Behaviour in the event of a failure of either the PGP controller or the associated measurement or the connection between PGP controller and PGU

When the inverter detects the communication interruption with the monitoring system, it needs to operate according to the preset active and reactive power.

If the inverter detects no valid data interaction with the monitoring system for a period of time, the communication is considered interrupted. Working according to preset active and reactive power configuration parameters. If the inverter detects that the communication is restored, the inverter will return to the active and reactive power parameters before the communication interruption.

When communication interruption is enabled, the interruption time shall be recorded.

If the interruption time reaches the preset communication interruption time, the operation shall be conducted according to the preset active and reactive power parameters.

Under the condition of communication recovery enabling, the current state is in the state of communication interruption. When a normal communication message is received and the time reaches the set value of communication recovery time, the communication is considered restored. At this time, the inverter operates according to the active and reactive power parameters at the last communication time.

The preset active and reactive power parameters are shown in the following table:

No.	Name	Address	Data range	Unit
1	Communication Interruption Configuration	31453	0xAA: Enable; 0x55: Disable	
2	Communication Interruption Time	31454	1-36000	s
3	Communication Interruption Recovery Configuration	31455	0xAA: Enable; 0x55: Disable	
4	Communication Recovery Time	31456	1-36000	s
5	Preset Power Limiting Percentage	31457	0 - 1000 or 0 - 1100 or 0 - 1300	0.001
6	Preset Reactive Power Regulating Mode	31458	0x55-Disable, 0xA1-PF, 0xA2-Qt, 0xA3-Q(P), 0xA4-Q(U)	
7	Preset Reactive Power Ratio	31459	-1000-1000	0.001
8	Preset Power Factor	31460	-800--1000, 800-1000	0.001
9	Preset Q(U) Curve	31461	0~2, 0: Curve A; 1: Curve B; 2: Curve C	
10	Preset Hysteresis Ratio	31462	0-50	0.001
11	Preset QU_V1	31463	800-1000	0.001
12	Preset QU_K1	31464	[-600-0]*Active Overload Rate/1000	0.001
13	Preset QU_V2	31465	800-1000	0.001
14	Preset QU_K2	31466	[-600-600]*Active Overload Rate/1000	0.001
15	Preset QU_V3	31467	1000-1200	0.001
16	Preset QU_K3	31468	[-600-600]*Active Overload Rate/1000	0.001
17	Preset QU_V4	31469	1000-1200	0.001

No.	Name	Address	Data range	Unit
18	Preset QU_K4	31470	[0-600]*Active Overload Rate/1000	0.001
19	Preset QU_EnterPower	31471	200-1000	
20	Preset QU_ExitPower	31472	10-200	0.001
21	Preset QU_EnableMode	31473	0xAA: Enable; 0x55: Disable, 0x5A: Limit PF Value	
22	Preset QU_LimitPFValue	31474	0-95	0.01
23	Preset Q(P) Curve	31479	0~2, 0: Curve A; 1: Curve B; 2: Curve C	
24	Preset QP_P1	31480	100~1000	0.001
25	Preset QP_P2	31481	200~1000	0.001
26	Preset QP_P3	31482	200~1000	0.001
27	Preset QP_K1	31483	Curve A/Curve C: 800~1000 Curve B: [-600~600]*Active Overload Rate/1000	0.001
28	Preset QP_K2	31484	Curve A/Curve C: 800~1000 Curve B: [-600~600]*Active Overload Rate/1000	0.001
29	Preset QP_K3	31485	Curve A/Curve C: 800~1000 Curve B: [-600~600]*Active Overload Rate/1000	0.001
30	Preset QP_EnterVoltageRatio	31486	1000~1100	0.001
31	Preset QP_ExitVoltageRatio	31487	900~1000	0.001
32	Preset QP_ExitPowerRatio	31488	10-200	0.001
33	Preset QP_EnableMode	31489	0xAA: Enable; 0x55: Disable	

0 1 2 3 4 5



5 DYNAMIC SIMULATION MODEL INFORMATION

5.1 Software Characteristics

- Software type: Simulator for Grid Connected Power Conversion System
- Simulation platform: DigSilent PowerFactory
- Used version of the simulation platform: 20.0.3_A2 (*)
- Simulation Software File identification: VDE_SG50CX_PF2018.pfd
- Dynamic Simulation Model version: V1
- MD5 Checksum: 7B9D30E70806F960D35E473F05C68EC6

(*) Simulation results offered in the validation report were obtained with the Powerfactory Digsilent Version 20.0.3_A2. The validation report doesn't cover upper version of Digsilent above V20.0.3_A2.

Revision 3

Report Number: 2221/0015-E1/A-TG4 demonstrates that the updated Dynamic Simulation Model (version 3.2) does not show any critical change compared to the previous version used in the original report number 2221/0015-E1-TG4. For more details see clause 3.1.3 of this Annex to Certificate

Software Characteristics used on Test Report 2221/0015-E1/A-TG4

- Validation report number: 2221/0015-E1/A-TG4
- Issuance date: 20-01-2022
- Issued by: SGS Tecnos, S.A. (Electrical Testing Laboratory)
- Simulation model name: VDE_SG33_40_50CX_PF2018
- Version of the simulation model: V3.2
- MD5 Checksum: F35B4A3146CD2FCEC35D1012BD8646E8
- Simulation platform: DigSilent PowerFactory 2021 SP4B
- Simulation platform version: 21.0.6.0 (11021) / Rev 83448 (*)

(*) Simulation results offered in the validation report were obtained with the Powerfactory Digsilent Version 21.0.6.0. The validation report doesn't cover upper version of Digsilent above Version 21.0.6.0.

5.2 Software Information and Comments

As evidenced in the manufacturer's documentation and the validation report, the dynamic model could be completely able to represent the dynamic behaviours at the PV inverter terminal, and also be suitable for power grid studies. The dynamic model covered by the validation report is valid for fundamental frequency positive and negative sequence response. The dynamic model is developed with the following specifications in mind:

- The model is to be used primarily for power system stability studies and thus should represent all positive and negative sequence dynamics affected and relevant during:
 - Balanced and unbalanced short-circuits on the transmission grid (including voltage recovery)
 - Grid frequency disturbances
 - Reference value changes
- The model is for fundamental frequency positive and negative sequence response.
- The model is valid for typical power system frequency deviations.
- The model is able to handle numerically the simulation of phase jumps.

- The model is valid for steady state voltage deviations within the range from 0.9 p.u. to 1.1 p.u.
- The model could work with integration time step range from 0.001s to 0.01s.
- The model could be initialized to a steady state from load flow solutions at full or partial nominal power.
- External conditions like solar radiation are taken into account through the available PV array conversion power.
- Over/under frequency and over/under voltage protections are modelled in the control model in order to allow a realistic representation of PV inverter disconnection following grid disturbances. This may be separate modules that connect to the main PV inverter model.
- The model includes the reactive power capability of the PV inverter.

0 1 2 3 4 5



5.3 Description of the model

The model has the following design:

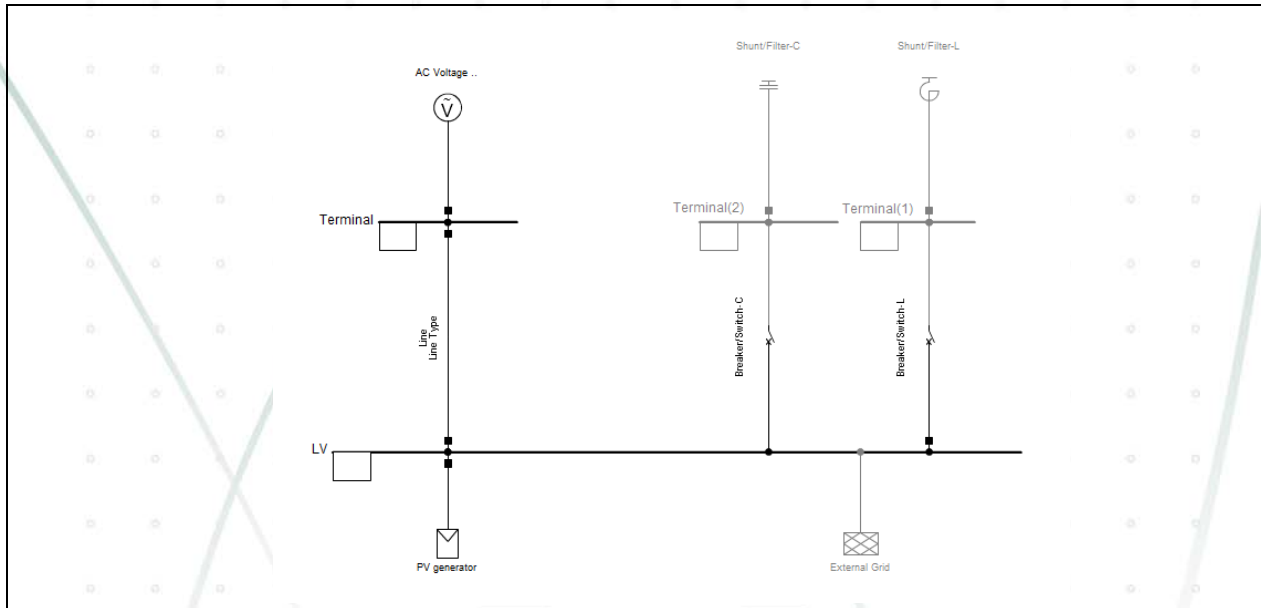

The grid information of SG50CX Digsilent project is as follows:

	SCR implemented in the simulated grid	Sampling resolution of simulation results
Validation requirements for Voltage Ride Through (LVRT and HVRT)	5	1 kHz (Step size is 1 ms)
Validation of changes commanded by set point (Active Power)	100	10 Hz (Step size is 100 ms)
Validation of changes commanded by set point (Reactive Power: Test 1 and Test 2)	100	200 Hz (Step size is 5 ms)
Validation of changes commanded by set point (Reactive Power: Test 3)	100	10 Hz (Step size is 100 ms)
Validation requirements for Reactive Power Control processes (QvsU for the shortest settling time and QvsP)	30	200 Hz (Step size is 5 ms)
Validation requirements for Reactive Power Control processes (QvsU for the longest settling time)	30	10 Hz (Step size is 100 ms)
Verification of requirements for Protective Settings (Under/Over voltage cases)	5	1 kHz (Step size is 1 ms)
Plausibility checks	5	10 Hz (Step size is 100 ms)
U-P-Q	100	5 Hz (Step size is 200 ms)
U-P-Q (90%Un for SG50CX)	100	10 Hz (Step size is 100 ms)

For further information, see the “User Manual and Model Description of DIgSILENT PowerFactory Model of SG33CX/SG40CX/SG50CX PV Inverter” (version 3.2, issued on 03rd December 2021).

The model can be adjusted to simulate models SG50CX, SG40CX or SG33CX as it is detailed following instructions given in points 2.1 to 2.3 of the user manual of the simulation model.

The SCR is calculated by:

$$SCR = M_{Sk}/P_n$$

Where, MSk is the short-circuit capacity of interconnected of point, Pn is the rated capacity of inverter.

And the impedance Zk of grid is calculated by:

$$Z_k = U_g^2 / (SCR * P_n)$$

Where, Ug is the rated voltage of inverter. The resistance is 10% of reactance for impedance.

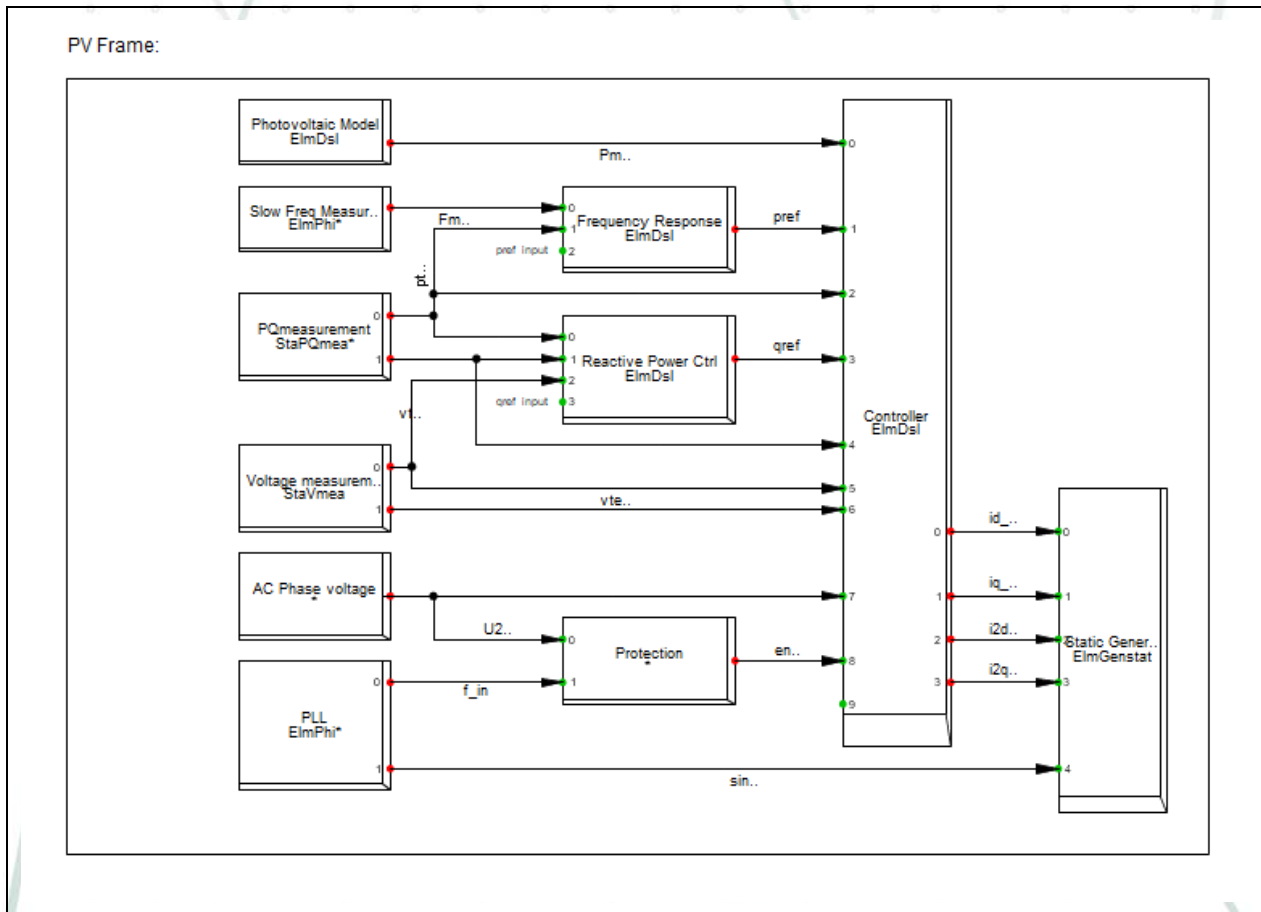

Below is showed the composite model linked with the PV-frame

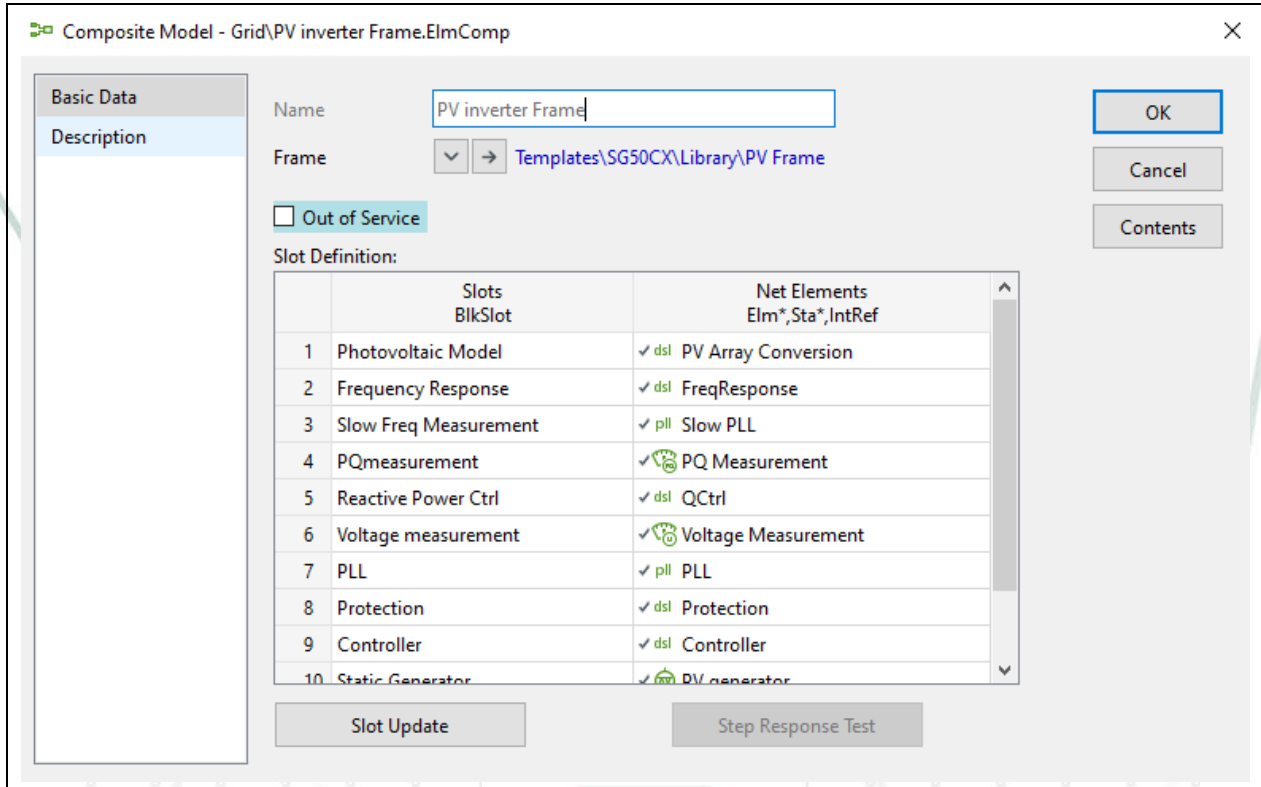

This controller block allows the user to configure main adjustable parameters of the simulated conversion system for LVRT/HVRT tests.

The following picture shows parameters adjusted by default for the simulations offered in this report.

Parameter	Value
I_{pmin} , Min. Active Current Limit [p.u.]	0,05
T_{filter} , PT1-Filter Time Constant [s]	0,002
K_p , Gain, Active Power PI-Controller [-]	1,
T_i , Integration Time Constant, Active Power PI-Controll...	0,05
U_{ac} , Rated AC-Voltage [V]	400,
deadband , Deadband for AC Voltg. Support [pu]	0,1
FRTen , Low/High Voltage Ride Through enable flag [0/1]	1,
ZPRTen , Zero Power Ride Through enable flag [0/1]	0,
Qpriority , Q priority for normal condition [0/1]	0,
I_{max} , Max. allowed absolute current [pu]	1,1
droop , k factor [-]	2,
k_{dp} , Act. current ramp after FRT [p.u./s]	8,
T_{delt} , Step time [s]	0,001
T_{Qen} , Reactive power generation time is greater than 5s...	1,
I_{qmin} , Min. Reactive Current Limit [pu]	-1,05
I_{pmax} , Max. Active Current Limit [p.u.]	1,05
I_{qmax} , Max. Reactive Current Limit [pu]	1,05

Just following parameters have been varied depending the case to evaluate:

- droop, k factor [-]. This flag set the K factor for LVRT and HVRT.
- ZPRTen, Zero Power Ride Through enable flag [0/1], This flag enables, with 1, or disables, with 0, the Limited Dynamic Grid Support Mode.

The configuration for LVRT three phase faults is the following:

Name	Breaker or Element StaSwitch,StaC...	Out of Service	Execution Time	Absolute h	Absolute min	Absolute s	Event defined by Elm*	Action	All phases	Phase a	Phase b	Phase c	Neutral
Switch Event	Breaker/Switch-L	<input type="checkbox"/>	01/01/1970 1:...	0	0	13,066		1	<input checked="" type="checkbox"/>	<input checked="" type="checkbox"/>	<input checked="" type="checkbox"/>	<input checked="" type="checkbox"/>	<input checked="" type="checkbox"/>
Switch Event(1)	Breaker/Switch-L	<input type="checkbox"/>	01/01/1970 1:...	0	0	13,881		0	<input checked="" type="checkbox"/>	<input checked="" type="checkbox"/>	<input checked="" type="checkbox"/>	<input checked="" type="checkbox"/>	<input checked="" type="checkbox"/>

The configuration for LVRT two phase faults is the following:

Name	Breaker or Element StaSwitch,StaC...	Out of Service	Execution Time	Absolute h	Absolute min	Absolute s	Event defined by Elm*	Action	All phases	Phase a	Phase b	Phase c	Neutral
Switch Event	Breaker/Switch-L	<input type="checkbox"/>	01/01/1970 1:...	0	0	13,818		1	<input type="checkbox"/>	<input type="checkbox"/>	<input checked="" type="checkbox"/>	<input checked="" type="checkbox"/>	<input checked="" type="checkbox"/>
Switch Event(1)	Breaker/Switch-L	<input type="checkbox"/>	01/01/1970 1:...	0	0	14,833		0	<input type="checkbox"/>	<input type="checkbox"/>	<input checked="" type="checkbox"/>	<input checked="" type="checkbox"/>	<input checked="" type="checkbox"/>

The resistance and the reactance are defined in the Shunt/Filter -L element.

The configuration for HVRT three phase faults is the following:

Name	Breaker or Element StaSwitch,StaC...	Out of Service	Execution Time	Absolute h	Absolute min	Absolute s	Event defined by Elm*	Action	All phases	Phase a	Phase b	Phase c	Neutral
Switch Event	Breaker/Switch-C	<input type="checkbox"/>	01/01/1970 1:...	0	0	12,174		1	<input checked="" type="checkbox"/>	<input type="checkbox"/>	<input checked="" type="checkbox"/>	<input checked="" type="checkbox"/>	<input checked="" type="checkbox"/>
Switch Event(1)	Breaker/Switch-C	<input type="checkbox"/>	01/01/1970 1:...	0	0	72,259		0	<input checked="" type="checkbox"/>	<input type="checkbox"/>	<input checked="" type="checkbox"/>	<input checked="" type="checkbox"/>	<input checked="" type="checkbox"/>

The susceptance is defined in the Shunt/Filter -C element.

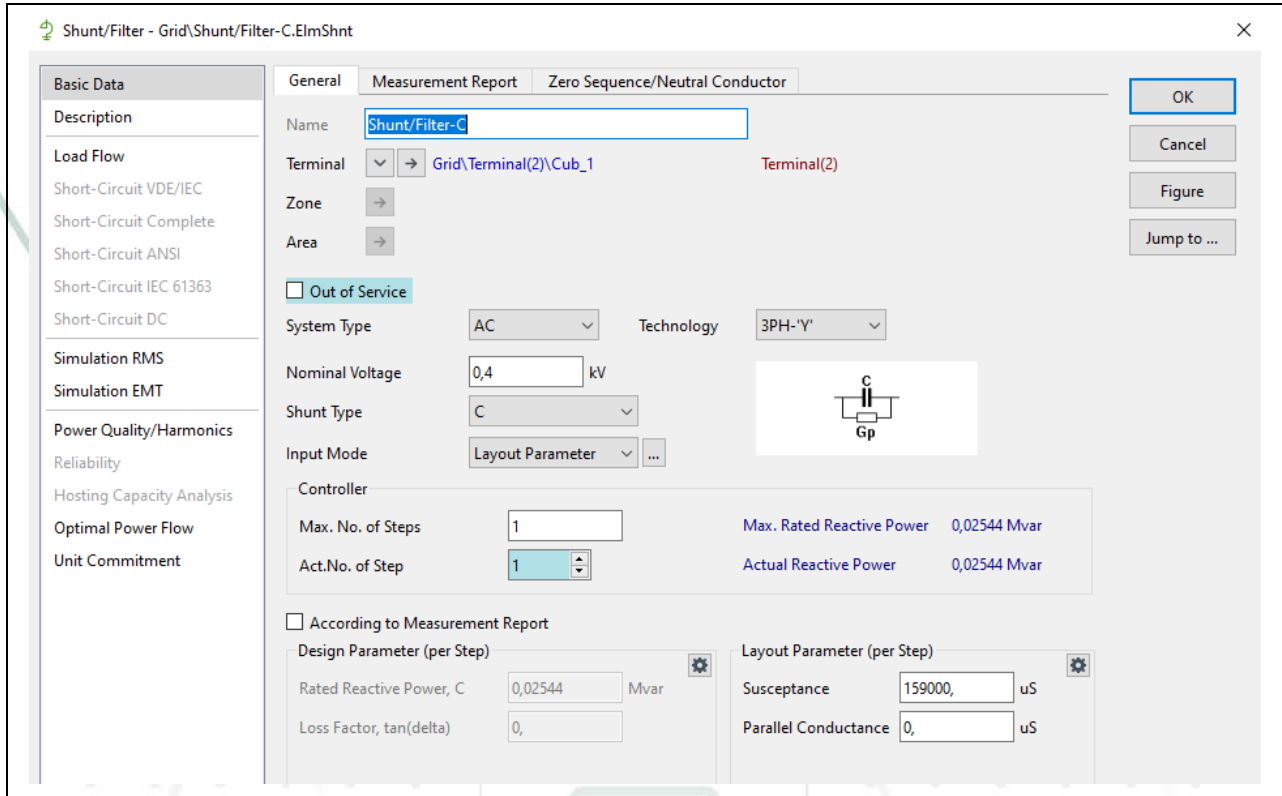

The slack node can also be configured for plausibility tests.

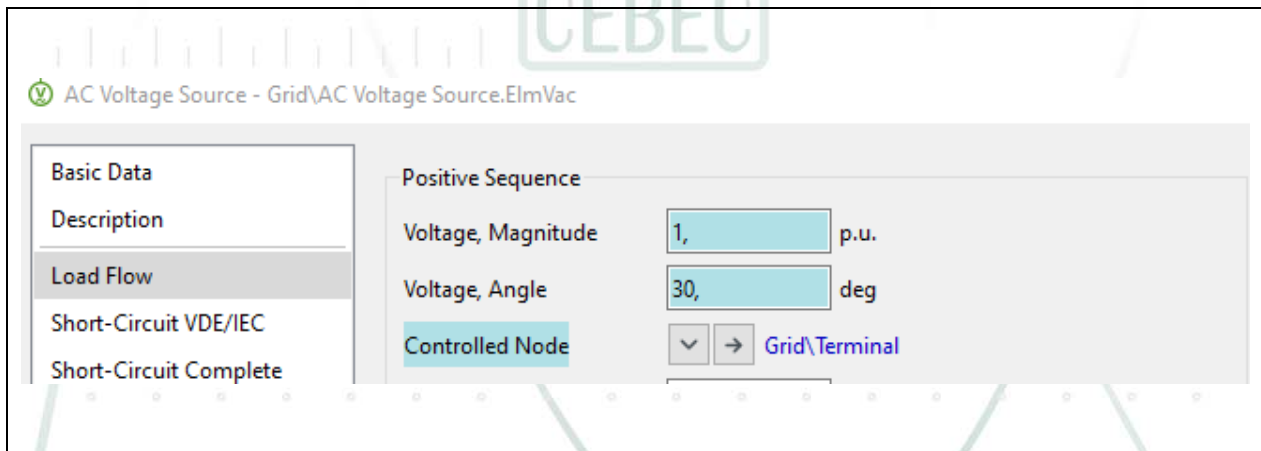

--- END OF THE ANNEX TO CERTIFICATE ---